

USER'S GUIDE

DIGIROLLER™ PLUS II

DIGITAL MEASURING WHEEL

MODEL 6425



- *Gebrauchsanweisung*
- *Guide de l'utilisateur*
- *Guía del usuario*



**CALCULATED
INDUSTRIES®**

Putting answers at your fingertips since 1978

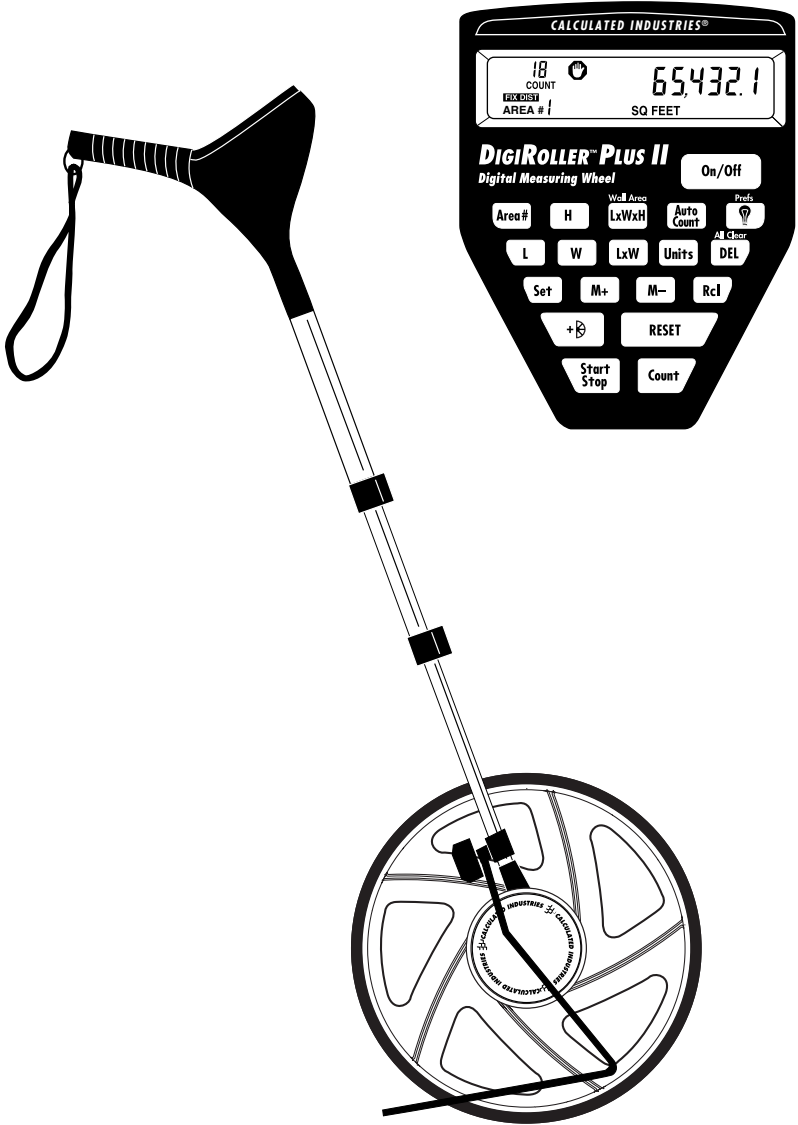

Introduction

THE DIGIROLLER™ PLUS II

The revolutionary *DigiRoller™ Plus II* is a digital measuring tool that lets you roll distances quicker and easier than ever before! Replacing the tape measure and mechanical measuring wheel, it measures linear distances and displays them digitally, calculates area and volume, stores multiple measurements in memory, and performs other handy functions that let one person measure faster, more accurately, and more conveniently. If your job involves measuring distances or taking square footage, the new *DigiRoller™ Plus II* is the tool for you!

- Large digital display located in handle for easy viewing
- Measures and stores Length, Width, and Height
- Calculates Area, Volume, and Wall Area
- Takes true “Wall-to-Wall” measurements
- Measurement unit selection and conversion
- Count and AutoCount functions
- Programmable “Fixed Distance”
- Stores up to nine different “Areas” or measurements
- Ergonomic and durable
- And much, much more!

Table of Contents

Getting Started

Turning the DigiRoller™ Plus II On/Off	3
DigiRoller™ Plus II Parts Diagram	4
Key Layout/Definitions	5
Using the Display	9
Display Test/Annunciators	10
Changing Units of Measurement	11
Turning the Bell On/Off	12

Taking Measurements

“Rolling” a Measurement	13
Storing/Recalling Values	15
Deleting Stored Measurements	16
Using the Counter	16
Taking Wall-to-Wall Measurements	17
Taking Area Measurements	18

Additional DigiRoller™ Plus II Features

Lighting the Display Background	21
Taking Volume Measurements	22
Storing/Recalling Multiple Measurements	25
Editing Stored Measurements	29
Deleting All Area Number Measurements	31
Taking Wall Area Measurements	32
Using AutoCount/Fixed Distance Mode	34
Deleting All Stored Values	35

Appendix

Changing Batteries	36
Changing/Calibrating Wheel Size	37
Default Settings	41
Error Codes	42
Caring for your DigiRoller™ Plus II	43
Common Questions/Answers	44
Product Specifications	46
Repair and Return	46
Warranty	47
German, French and Spanish Translations	48

GETTING STARTED

Turning the DigiRoller™ Plus II On/Off

On/Off Key



Turn the *DigiRoller™ Plus II* on by pressing the [On/Off] key. To turn it off, press the key again.

Auto Shut-Off

The *DigiRoller™ Plus II* is designed to shut itself off if not used for 4-6 minutes. Values shown on the display will be cleared. However, when you turn the unit on again, the previously displayed value will re-display. All stored values will be retained.

To Set To Metric Mode

1. Turn unit on.



2. Press the [Set] key.



3. Press the [On/Off] key.



4. Press and hold the [Reset] key.



5. Press the [On/Off] key while continuing to hold the [Reset] key.



6. Press the [Rcl] key to enter Metric Mode.



*Press the [LxW] key to enter Imperial Mode.



DigiRoller Plus™ II Parts

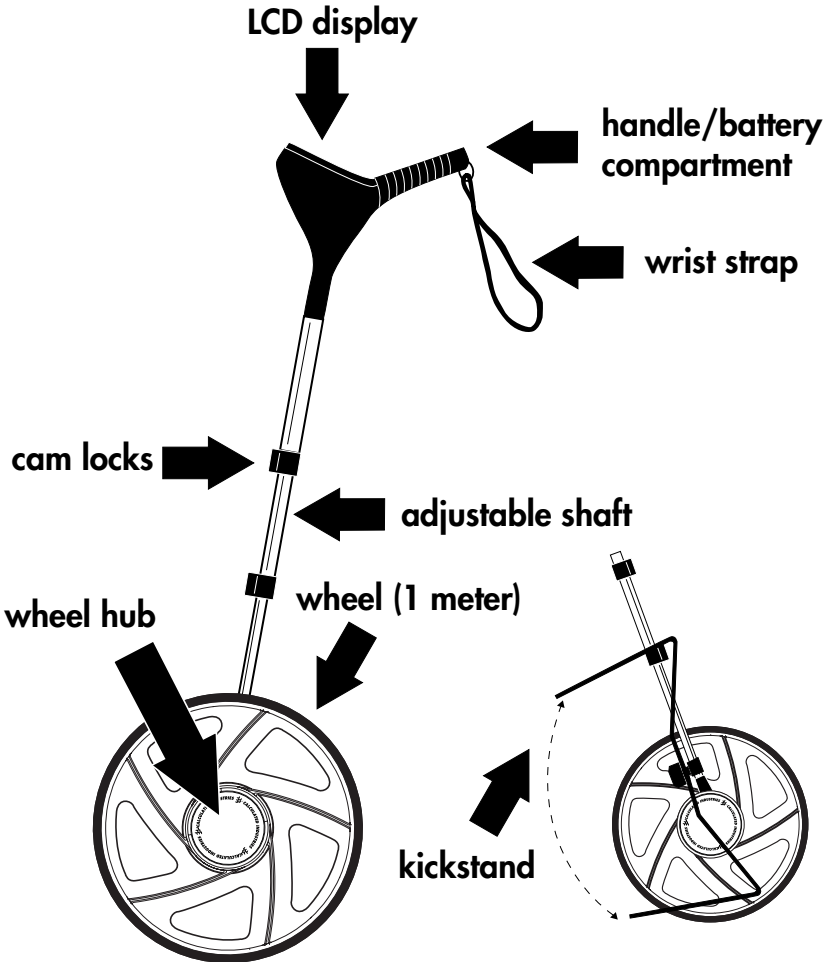

Key Layout / Definitions

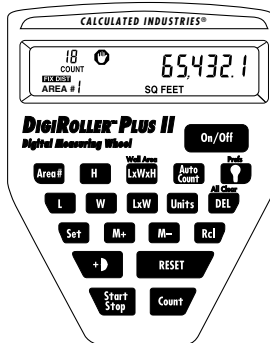

The *DigiRoller™ Plus II* is unique to measuring wheels because it has keys that allow you to store and manipulate the distances measured.

The following is a list of keys that you may use as you operate the unit: (see page 10 for a list of LCD annunciators)

On/Off

Power On/Off Key — Turns the unit on or off.

L

Length Key — Enters and stores rolled length value.

W

Width Key — Enters and stores rolled width value.

LxW

Area Key — Calculates and displays rolled area. Multiplies the entered length value by the entered width value.

Units

Units of Measurement Key — Selects desired unit format: Feet-Inches, Decimal Feet, Decimal Inches, Yards, Meters, and Acres (area display only). Each press of this key will convert the displayed measurement to another unit format.

All Clear**DEL**

Delete/All Clear Key — Deletes, or erases, the values stored in the next key pressed (e.g., [DEL] [L] deletes the current measurement stored as length, [DEL] [W] deletes the current measurement stored as width, etc). To perform an All Clear, press [Set] [DEL] [DEL]. This key sequence will clear all stored data and memory registers.

Rcl

Recall Key — Recalls and displays the value of the next key pressed (for example, [Rcl] [W] displays the value stored in the Width key). [Rcl] [Rcl] will recall a previously rolled value that has been cleared or deleted.

M+

Memory Add Key — Stores any displayed value into permanent memory. When you store a value in memory, it is added to the values you previously stored in memory. Note that you cannot add two measurements of different levels of dimensions (for example, you cannot add feet-inches and square feet).

M-

Memory Subtract Key — Subtracts the displayed value from permanent memory.

Set

Set Key — Used to access special functions.

+ 

Add Wheel Radius Key — Adds the wheel radius (first press) or diameter (second press) to the total linear measurement, to allow for true wall-to-wall distance.

RESET

Reset/Clear Display Key — Clears the display to 0. Does not clear stored values.

Start
Stop

Start/Stop Key — This key switches the unit between start and stop modes. You will press this key to begin measuring. When you are in stop mode, a stop sign annunciator () will display and the unit will stop measuring. Press [Start/Stop] to resume measuring from where you left off, or [RESET] to start from zero.

Count

Manual Count Key — Each time you press this key, the unit will show the count in the upper left of the display. The unit will count from 1-199, and then will roll over and continue counting from one. However, if you press [Rcl] [Count], the accumulated total will display (for example, 203) on the right side of the display. Press [Del] [Count] to clear count to zero.

Area#

Multiple Area Storage Key — This key allows the storage of up to nine different room areas (length and width). After storing the first area values, pressing this key will allow the storage of additional values. This can be repeated for up to nine entries. This key is also used to toggle between the different room areas.

 H

Height — Stores a height value (rolled or entered) for calculating cubic volumes and wall areas. The height value will carry over to the next room area, unless changed by the user.

Wall Area

 LxWxH

Volume — Calculates volume measurements from entered or stored length, width, and height values.

 Auto
Count

AutoCount Mode — Places the unit in “AutoCount” Mode, allowing you to program a fixed distance to be automatically counted at each occurrence. The *DigiRoller™ Plus II* will automatically increase the count each time it reaches the distance you have set (for example, it will count the number of times you roll five feet), and show the number of times it has measured this distance on the upper left of the display.



Light Key — Turns the display back-light on or off.

Preferences

[Set] [Light] — Scrolls through the *DigiRoller™ Plus II* Preference Settings, which include:

- Bell On/Off
- Wheel Size
- LCD Contrast Control
- Calibration and Percentage Calibration

(Detailed use of each of these preference settings are discussed later in the guide.)

Using the Display

Clearing the Display

RESET

To clear the display, press the [RESET] key. This will clear the display and place the *DigiRoller™ Plus II* into a measuring mode.

Changing the Display Contrast Level

Set



You can control the brightness of the display by adjusting the contrast level setting.

1. Press the [Set] then [Light] keys to enter the preference setting.
2. Press the [Set] key to scroll to Preference 3, “Contrast” setting.



3. Press the [M+] or [M-] key to adjust the display contrast level to the desired setting.

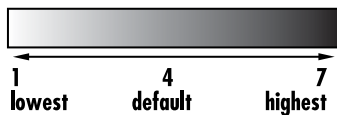

4. Press [RESET] to exit.

Display Test/Annunciators

Rcl

Start
Stop

To perform a display test and light all annunciators, press [Rcl] [Start/Stop]. Press [RESET] to clear the display test.

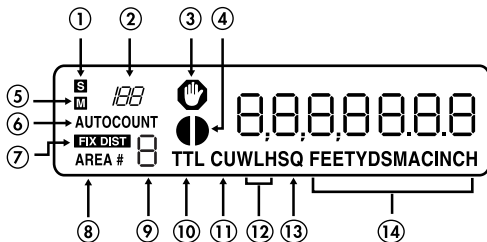

- (1) Set symbol
- (2) Count number
- (3) Stop symbol
- (4) Wheel Radius symbol
- (5) Memory symbol
- (6) Count/AutoCount symbols
- (7) Fixed Distance symbol
- (8) Area Number symbol
- (9) Area Number indicator
- (10) Total symbol
- (11) Cubic symbol
- (12) Width, Length, Height symbols
- (13) Square symbol
- (14) Units of measurement symbols

Changing Units of Measurement

The *DigiRoller™ Plus II* can display and convert between the following units of measure:

- Feet-Inch
- Decimal Feet
- Inches
- Yards
- Meters
- Acres (for displaying area values only)

You select your preferred unit of measure with the [Units] key. Each press will advance through the above unit settings.

Any measurement on the display can be converted to the desired unit of measure by pressing the [Units] key. For example, if the display shows:

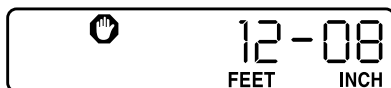

and you would rather see the value displayed in inches, press the [Units] key. You will see:



You can select different units of measurement for each measure convention (linear, square, cubic) just by pressing the [Units] key while displaying any linear, square or cubic value. The units of measurement you choose will remain as they were last displayed until you change them (even if you turn off the *DigiRoller™ Plus II*).

Turning the Bell On/Off

Set

The *DigiRoller™ Plus II* has a built-in bell sound, which you can turn on or off. The bell is only heard when you are using the Count/Auto Count functions. To turn the bell on or off, press the following keys:

1. Press [Set] then [Light] keys to enter the Preference Mode.
2. The display will show Preference 1, “Bell On” setting.
Press [M+] or [M-] if you wish to turn the bell sound off.
3. Press the [RESET] key to exit.

Note: You may have trouble hearing the bell in noisy outdoor settings.

TAKING MEASUREMENTS

“Rolling” a Measurement

Here’s how to take a measurement with the *DigiRoller™ Plus II*:

1. Turn the unit On by pressing the [On/Off] key. If the display does not show zero (0), press the [Reset] key to clear the display.



2. Begin walking while rolling the *DigiRoller™ Plus II*. You will see the display registering your measurements.

Note: If you move the handle up or down while you are using the unit, you will add or subtract a small distance (zero inches to four inches) to any roll. For this reason, it is important to try to keep the unit in the same position throughout the roll.

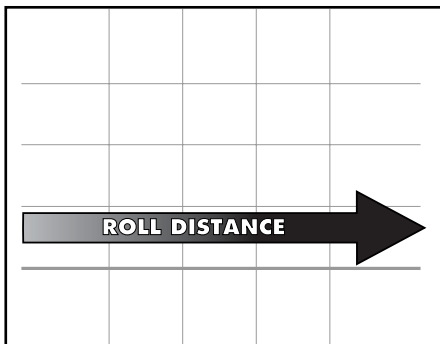

3. When you are finished measuring, press the [Start/Stop] key.



4. If you wish to store the measurement, press [L] for length, [W] for width or [H] for height. Press the [Start/Stop] key to begin a new movement.



5. If you do not wish to store the measurement, you may either press the [Start/Stop] key to continue from where you left off or press [RESET] to start measuring from zero.

Storing / Recalling Values

The *DigiRoller™ Plus II* has several keys that can be used to store and recall values:



The *DigiRoller™ Plus II* can also store and recall values in the [H], [LxWxH], [AutoCount], and [Area#] keys.

To recall any of the values above, press the [Rcl] key and then press the key that has the value you want to display. For example, to recall the length that was rolled, press [Rcl] [L].



Storing Measurements in Permanent Memory

A black calculator key with white text 'M+'.A black calculator key with white text 'M-'.

You can store rolled measurements in the standard calculator type memory, by pressing the [M+] key after rolling. To subtract a measurement from a previously stored value, press the [M-] key after rolling. To recall the total stored in Memory, press [Rcl] [M+].

Note: This memory feature acts just like a standard, limited calculator memory function; it will accumulate and total the measurements added to it.

Deleting Stored Measurements

DEL

To permanently delete a stored value, press the delete key [DEL] and then the key that has the value you want to delete. Be careful when pressing the [DEL] key, as it will permanently erase the stored value of the next key pressed.

If you accidentally press the [DEL] key, press [RESET] to prevent any stored value from being erased.

Using the Counter

Count

The *DigiRoller™ Plus II* has a manual “count” function that allows you to count various items you may be tracking as you roll your measurement (for example, parking spaces, fire hydrants, etc.).

When you want to count something, press the [Count] key. If the bell is on, the unit will beep each time it is pressed and the count total in the upper left corner of the display will increase by one. To subtract a count, press the [Set] key then the [Count] key.

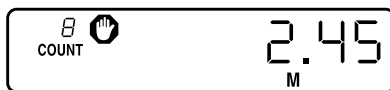

Taking Wall-to-Wall Measurements



Unlike other measuring wheels, the *DigiRoller™ Plus II* has a built-in function which enables you to measure true wall-to-wall distances (taking into account the wheel's radius when measuring up to a wall). The wheel radius key will add the radius of the wheel to the measurement.

To measure a room accurately, press the wheel radius key whenever your measurements begin or end against a wall (see instructions below).

When you press this key, the *DigiRoller™ Plus II* will add distance to the measurement. Depending on your selected wheel size and measurement units, the first and second presses of this key may not *appear* to be adding equal distances due to display rounding. However, this is a display value only; internal calculations will be accurate.

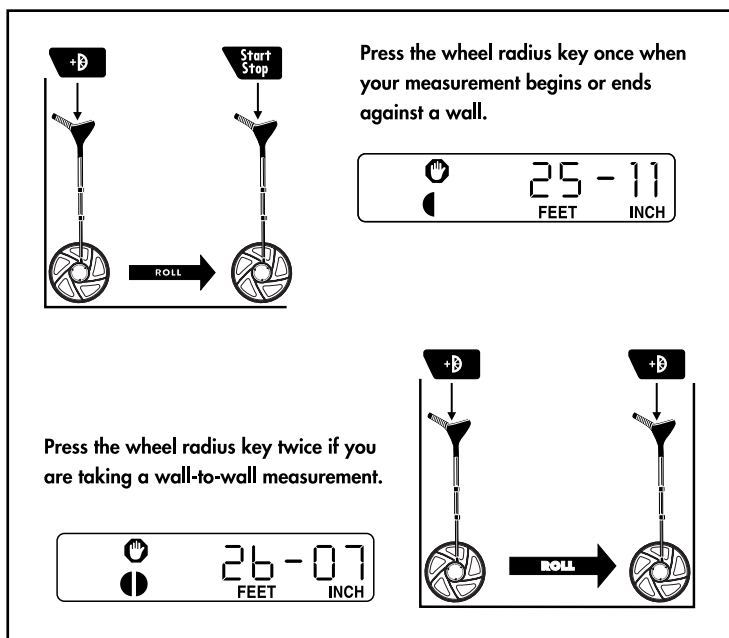

Taking Area Measurements

LxW

Your *DigiRoller™ Plus II* automatically calculates areas once you've rolled a length and width. Remember, press [RESET] to begin each new measurement.

1. Roll the first distance. Press the length key [L] and your rolled distance will be automatically stored as the length.

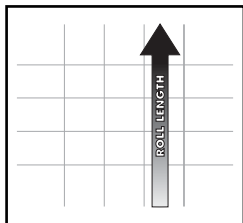

2. Press [RESET]. Roll the second distance and press the width key [W].

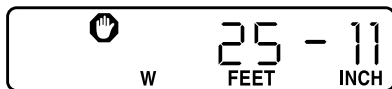
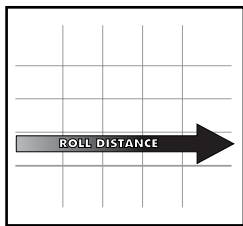

3. Press [RESET]. Press the [L x W] key to calculate the area.

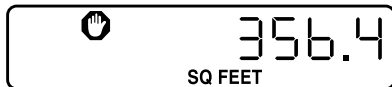

Calculating Complex Areas

You can calculate complex areas using the *DigiRoller™ Plus II* easily. Using the memory keys [M+], [M-], you can add and subtract measurements from your total area. See the diagram below.



To find the total area, you will need to divide the area to be measured into sections (see diagram below) and find the area for each section. Then you can subtract the empty area from the total area.

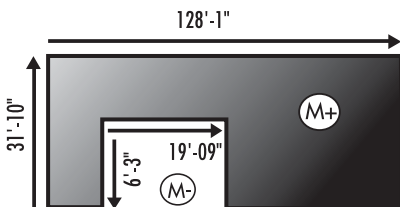

Step 1 - Find the total area:

Step:

Roll length of first section and store

Key:

[RESET]

[L]



Step: _____ **Key:**

[RESET]

Roll width and store [W]

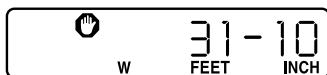

Find area [L x W]
Store area in memory [M+]

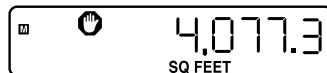

Step 2 - Find area to be subtracted

Step: _____ **Key:**

[RESET]

Roll length of empty space and store [L]



[RESET]

Roll width and store [W]



Find area [L x W]

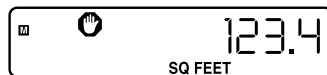

Subtract from total in memory [M-]

Calculate actual area [Rcl] [M+]

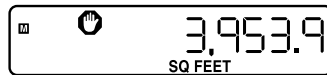

ADDITIONAL DIGIROLLER™ PLUS II FEATURES

Lighting the Display Background



The *DigiRoller™ Plus II* has a built-in back-light to light up the display so that measurements can be seen in poorly-lit environments.

1. Press the [Light] key to light up the display.
2. Press the key again to turn the light off.

Using the light consumes battery power more rapidly, thus the *DigiRoller™ Plus II* will automatically turn off the light after approximately thirty seconds of inactivity. Use it only when necessary and turn it off when you are done.

Taking Volume Measurements



LxWxH

The *DigiRoller™ Plus II* is programmed to quickly and easily calculate volumes if you've rolled in a height or if you've set a fixed height.

You can roll or set a height for each of the nine Area Number storage registers. Once you roll or set a height, it is used for all subsequent volume calculations unless you change it.

Remember to press [Reset] to begin each new measurement.

Calculating Volume Using a Rolled Height

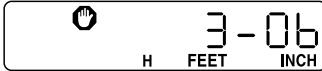
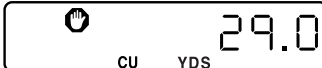
Step:	Key:	
Roll length	[L]	
	[RESET]	
Roll width	[W]	
	[RESET]	
Roll height	[H]	
Find volume	[LxWxH]	

Calculating Volume Using a Fixed Height

Set**H**

To set or program a fixed height, for example, eight feet seven inches, do the following:

Step	Key
------	-----

Enter program mode	[Set] [H]
--------------------	-----------

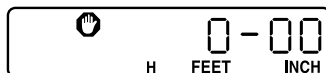

The Feet-Inch annunciator will start flashing. Press [M+] if you want to change the units of measurement. The display will scroll through the various units of measurement. Press [Set] to select the unit of measure and begin storing. The first zero (0) will start flashing.

Accept Feet-Inch as Units	[Set]
---------------------------	-------

Enter 8 feet	[M+] (press eight times) ([M-] to subtract)
--------------	--

Store measurement	[Set]
-------------------	-------

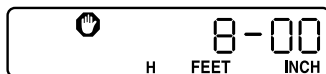

Enter 7 inches	[M+] (press seven times) ([M-] to subtract)
----------------	--

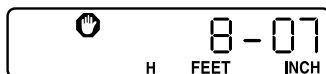

Store height/depth	[Set]
--------------------	-------



Clear display	[RESET]
---------------	---------

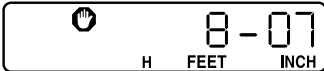
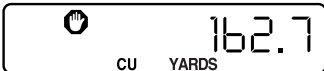

Now you can find the volume using the fixed height you've just set. Remember to press [RESET] to begin each new measurement.

Step	Key	
Roll length and store	[L]	
	[RESET]	
Roll width	[W]	
	[RESET]	
Recall fixed height (optional)	[Rcl] [H]	
Find cubic volume	[LxWxH]	

Storing / Recalling Multiple Measurements



Your *DigiRoller™ Plus II* has a unique [Area#] key used for storing and recalling multiple measurements. You can store length, width, height, area, and volume for each of the nine [Area#] registers. You can recall these measurements later, even if you turn off the *DigiRoller™ Plus II* (for example, to review your measurements back at the office). When you recall your measurements, you can also view totals for each (L, W, H, LxW, LxWxH, Wall Area).

Area #	L	W	H	LxW	LxWxH	Wall Area
1	<input type="text"/>	<input type="text"/>	<input type="text"/>	<input type="text"/>	<input type="text"/>	<input type="text"/>
2	<input type="text"/>	<input type="text"/>	<input type="text"/>	<input type="text"/>	<input type="text"/>	<input type="text"/>
3	<input type="text"/>	<input type="text"/>	<input type="text"/>	<input type="text"/>	<input type="text"/>	<input type="text"/>
4	<input type="text"/>	<input type="text"/>	<input type="text"/>	<input type="text"/>	<input type="text"/>	<input type="text"/>
5	<input type="text"/>	<input type="text"/>	<input type="text"/>	<input type="text"/>	<input type="text"/>	<input type="text"/>
6	<input type="text"/>	<input type="text"/>	<input type="text"/>	<input type="text"/>	<input type="text"/>	<input type="text"/>
7	<input type="text"/>	<input type="text"/>	<input type="text"/>	<input type="text"/>	<input type="text"/>	<input type="text"/>
8	<input type="text"/>	<input type="text"/>	<input type="text"/>	<input type="text"/>	<input type="text"/>	<input type="text"/>
9	<input type="text"/>	<input type="text"/>	<input type="text"/>	<input type="text"/>	<input type="text"/>	<input type="text"/>
Totals	<input type="text"/>	<input type="text"/>	<input type="text"/>	<input type="text"/>	<input type="text"/>	<input type="text"/>

Remember to press [RESET] to begin each new measurement.

Step:

Key:

(Area #1)

Roll length and store

[L]



[RESET]

Roll width and store

[W]

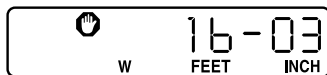

[RESET]

Find area

[LxW]

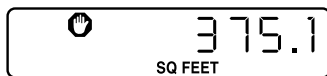

Store as Area #1

[Area#]

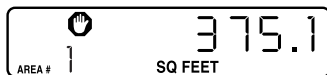

[RESET]

(Area #2)

Roll length and store

[L]



[RESET]

Roll width and store

[W]

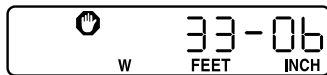

[RESET]

Find area

[LxW]

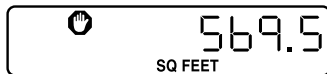

Store as Area #2

[Area#]



Continue the above steps for each area you wish to calculate and store, up to nine areas.

If you try to store a tenth value, the word “FULL” will display. Press [RESET] to clear this error message. If you want to add this last value, you must then delete and/or edit the values stored in the Area Number registers. See the “Editing Stored Measurements” section (page 29) for information on editing values in the Area Number registers.

Recalling Stored Measurements

Rcl**Area#**

To review your stored areas, press [Rcl] [Area#]. The last Area Number measurement that you stored or recalled will be displayed. Once you press these two keys, you can review all stored values for each Area Number – length, width, height, area, volume, wall area and totals for each.

Step:

Key:

Area# 1

[Rcl] [Area#] (until Area# 1 appears)

Recall length

[L]



Recall width



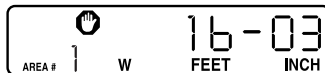

[W]

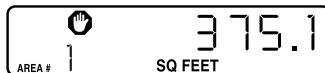

Recall area

[LxW]

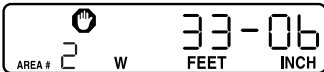
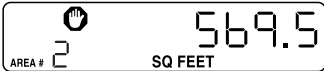

Recall Area #2	[Area#]	
Recall length	[L]	
Recall width	[W]	
Recall area	[LxW]	
Recall total area	[Area#]	

Continue until you have reviewed all your stored measurements. To exit the Area Number review mode, press [RESET].

Editing Stored Measurements

Duplicating values in an Area Number register:

Step	Key
Find Area Number Register with the value you want to duplicate	[Area#]
Find the value you want to duplicate	[L] OR [W] OR [H]
Store measurement in permanent memory	[M+]
Find Area Number with the value you want to replace	[Area#]
Recall replacement value	[Rcl] [M+]
Replace old value with duplicated value	[Set] [L] OR [Set] [W]

To replace a value in an Area Number register:

Step	Key
Roll measurement	[Start/Stop]
Store measurement in permanent memory	[M+]
Find Area Number Register with the value you want to replace	[Area#]

Step	Key
Find the value you want to replace	[L] OR [W] OR [H]
Recall replacement value	[Rcl] [M+]
Replace old value with new value	[Set] [L] OR [Set] [W]

Deleting a value in an Area Number register:

Step	Key
Find Area Number Register with value you want to delete	[Area#]
Delete value	[DEL] [L] OR [DEL] [W] OR [DEL] [H] OR [DEL] [LxW] OR [DEL] [LxWxH]

Note that deleting [LxW] and/or [LxWxH] also deletes the individual measurements contained (length, width, height).

Deleting an individual Area Number register ([L], [W], [H]):

Press [DEL] [Area#].

Deleting All Area Number Measurements

SetDELArea#

Use the following special three key sequence to clear all measurement values previously stored in the [Area#] key: press [Set] [DEL] [Area#].

CAUTION: ALL stored values in [Area#] will be erased at once.

Taking Wall Area Measurements

Wall Area

Set

LxWxH

The *DigiRoller™ Plus II* can calculate the total wall surface area of a room. Wall area is defined as:

$$([\text{Length} \times 2] \times \text{Height}) + ([\text{Width} \times 2] \times \text{Height})$$

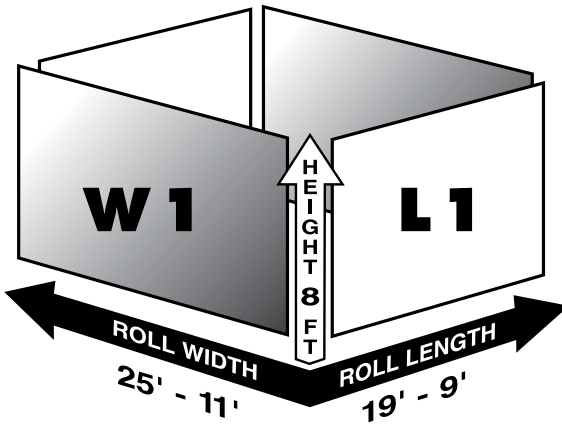

You will only need to roll a length and width, and roll or set a height. Then you can calculate the total wall surface area of that room. See the “Taking Volume Measurements” section (page 22) for information on rolling or setting a fixed height.

Remember to press [RESET] to begin each new measurement.

Step	Key
------	-----

Set or roll height
(See "Taking Volume Measurements" section)

Roll length of wall	[L]
---------------------	-----

[RESET]



Roll width	[W]
------------	-----

[RESET]

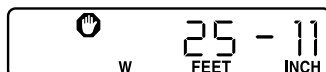

Recall height	[H]
---------------	-----

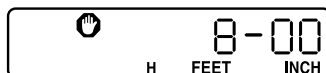

Find wall area	[Set] [LxWxH]
----------------	---------------

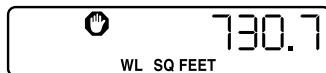

Using AutoCount/Fixed Distance Mode

Auto
Count

The *DigiRoller™ Plus II* has an AutoCount mode that allows you to count how many times you've rolled a programmed distance (that you've set). If the bell is on, you will hear a short beep each time you roll that distance and the counter in the upper left of the display will increase by one.

For example, you want to count the number of times that you roll 6 feet 8 inches.

Step:

Key:

Enter AutoCount Mode
(*Feet-Inch* starts flashing)

[Set] [AutoCount]

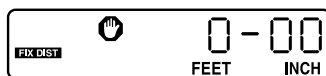

The Feet-Inch annunciator will start flashing. Press [M+] if you want to change the units of measurement. The display will scroll through the various units of measurement. Press [Set] to select the measurement unit and begin storing. The first zero (0) will start flashing.

Accept Feet-Inch as Units [Set]

Enter 6 feet [M+]
(0 starts flashing) (press six times)



Store feet measurement [Set]
(-00 starts flashing)



Enter 8 inches [M+]
(press eight times)



Store inch measurement [Set]

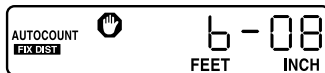

Clear the display [RESET]

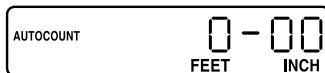

Begin rolling. The unit will automatically count the number of times you roll six feet eight inches and beep each time.

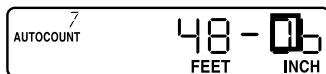

Deleting All Stored Values

Set

DEL

DEL

To clear all registers and stored values, press [Set] [DEL] [DEL].

CAUTION: All stored values will be erased!

Changing Batteries

4 AAA

The *DigiRoller™ Plus II* is powered by four AAA batteries. For best results, use DURACELL® (MN-2400) batteries. The batteries normally provide approximately 400 hours of use. You should replace the batteries when:

- the display becomes weak or erratic
- the words “**Lo batt**” show on the display
- the display light is dim

1. Turn the unit off and position the unit so that the handle faces you. Using a small screwdriver, unscrew the battery compartment cover (see the diagram below). Remove the cover.

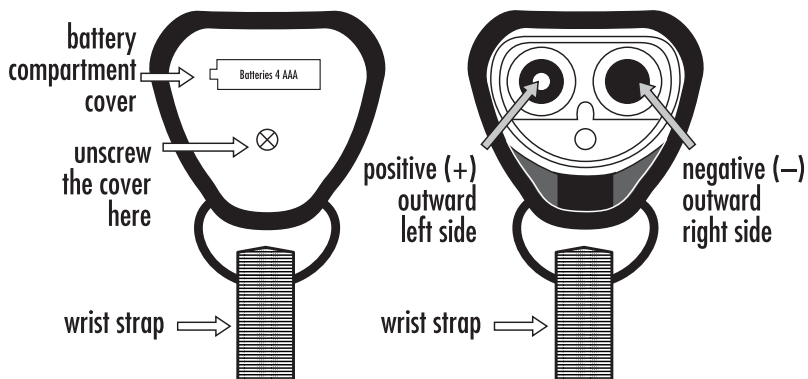

2. Remove all four batteries and insert four new ones. Insert two of the batteries on the left side with the positive ends facing outward; insert the other two batteries on the right side with the negative ends facing outward (see diagram).
3. Replace battery compartment cover. Tighten the screw on the cover.

***CAUTION: Batteries contain hazardous chemicals.
Please dispose of used batteries properly.***



Changing / Calibrating Wheel Size (Optional)

For your convenience, the *DigiRoller™ Plus II* is designed to work with three different size wheel circumferences: One meter (standard; default), two foot and four foot (sold separately).

If you already own or have purchased a two or four foot wheel size,* use the following procedure to change wheels:

1. Turn the unit off and place it in front of you on a flat surface, so that the threaded axle shaft faces up.
2. Unscrew the wheel hub cover by turning it in a counter-clockwise direction.

**The two and four foot wheels are no longer available.*

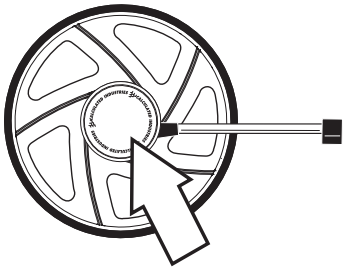

Remove wheel hub cover

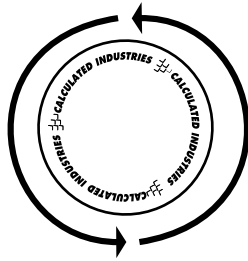

Turn counter-clockwise

3. Remove the wheel hub cover from the threaded axle shaft.
4. Remove the old wheel from the unit.
5. Place the wheel on the threaded axle shaft.
Important: The flat spot inside the wheel hole MUST be aligned to the flat spot on the threaded axle shaft in order for the wheel to mount properly.

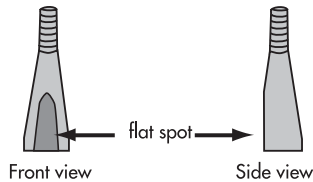

threaded axle shaft

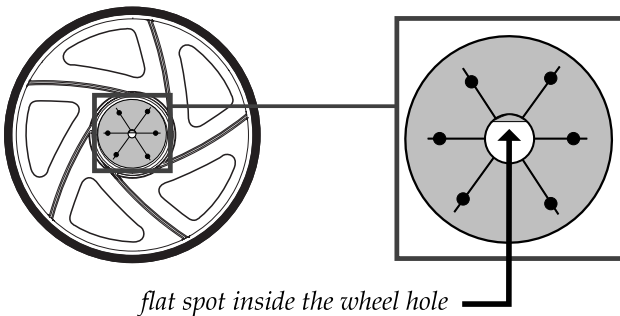

flat spot inside the wheel hole

- Put the wheel hub cover back in place and turn it in a clock-wise direction to close. Tighten the cover so that there is no space between the cover and the wheel and make sure that the wheel does not wobble. Do not over-tighten wheel hub cover.

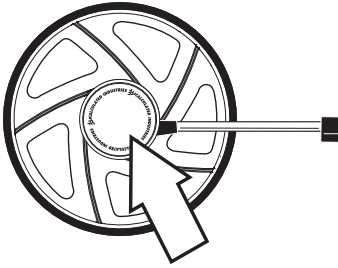

Replace wheel hub cover

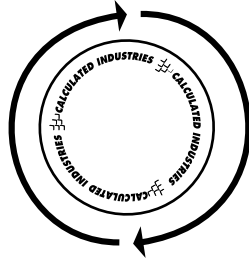

Turn clockwise to close

- See the following section for directions on calibrating for the new wheel size.



You will need to recalibrate the *DigiRoller™ Plus II* if you change the wheel size.

You must reprogram the unit to accept a different wheel circumference size so that it will measure correctly.

1. Turn unit on.
2. Press [Set] then the [Light] key to enter the preference mode.
3. Press [Set] to scroll to preference 2, “wheel size” setting.
4. The default is one meter. To select two or four foot circumference wheel size, press the [M+] key to advance to two or four feet.
5. Press the [RESET] key to exit.

Default Settings

The default settings for the *DigiRoller™ Plus II* are:

- Feet-Inch Mode
- One Meter Wheel
- 100% Wheel Calibration*
- Display Contrast Level 4
- Bell On

*On the *DigiRoller™ Plus II*, you can reset the unit by pressing [Set] then press the [Light] key four times. This will display:



Press [Reset] to clear the display and begin measuring.

Changing the Calibration Percentage

You can change the wheel calibration percentage to be less than or greater than 100%, to add or subtract a percentage factor to your measurements. To change the calibration percentage:

1. Press the [Set] then [Light] keys.
2. Press the [Set] key to scroll to preference 4, calibration setting.
3. Use the [M+] and [M-] keys to move the percentage up or down. Press [Set].
4. Press the [RESET] key to exit.

Error Codes

When an error occurs, the display will show one of the following messages:

<i>Error 1</i>	Attempt to enter a wheel ratio of 0%
<i>Error 2</i>	Attempt to add values of unlike dimensions in memory
<i>Error 3</i>	Attempt to move a current room with 0 length, 0 width, and non-zero height into the area key
<i>nonE</i>	Attempt to enter fixed distance or AutoCount mode with zero (0) stored in the fixed distance key
<i>Lo batt</i>	Low battery power
<i>FULL</i>	Attempt to move measurement(s) into the Area Number registers but all Area Number registers are full
<i>OFLO</i>	Attempt to display a value too large for display

Most errors can be cleared by pressing the [RESET] key.

Caring for Your DigiRoller™ Plus II

1. Keep the LCD display and keypad protected from prolonged exposure to water. Wipe off excessive moisture.
2. Avoid temperatures below -10°C (14°F) or above 60°C (140°F).
3. Even though this product is extremely durable, take care not to drop or strike against objects.
4. When you see the “**Lo batt**” indicator, replace the batteries. You may purchase batteries at any store.
5. If you change the wheel, be sure to re-calibrate the unit so that it will measure correctly.
6. As with all measuring wheels, measurements will vary when rolling “against the grain” of the carpet. Be sure to take this difference into account when measuring indoors.

Common Questions / Answers

Q: My *DigiRoller™ Plus II* won't register measurements when I roll. What's wrong?

A: Make sure you press the [Start/Stop] key to start your measuring (display will no longer show the stop symbol when unit is in start or measuring mode).

Q: My display shows the words “**Lo batt.**” What does this mean?

A: When you see the Low Battery Indicator “**Lo batt.**,” replace all four of the AAA batteries. You may purchase replacement batteries at any store.

Q: My *DigiRoller™ Plus II* display is dim and hard to read. How can I make the display easier to read?

A: You may adjust the LCD contrast control for easier viewing (see the section “Changing the Display Contrast Level” on page 9 for instructions on changing the contrast level).

Q: My measurements are coming up (long/short) when I roll on carpet. What's wrong?

A: As with all measuring wheels, measurements will vary when rolling “against the grain” of carpet. Be sure to take this difference into account when measuring indoors.

Q: I've taken several measurements for the same thing but the measurements are different. Is something wrong with the *DigiRoller™ Plus II*?

A: When you are measuring a distance, you need to ensure that you start and stop your measurement while holding the *DigiRoller™ Plus II* at the same angle (preferably upright or vertical). If you do not, your measurement may be inaccurate. When you move the unit from an angled to a vertical position or vice versa, the unit will add or subtract by as much as four inches, therefore changing the overall measurement. Also, rolling the unit backwards will subtract measurement units.

Q: My wheel “wobbles” when I roll the unit – is this normal?

A: When the wheel starts to wobble, you should check two things:

- 1) check that the flat spot inside the wheel hole and the flat spot on the axle shaft are aligned;
- 2) check that the hub cover is on finger tight (approximately 1/2 additional turn after the wheel hub cover touches the wheel surface).

Product Specifications

Power Source:	Four AAA Duracell® Batteries
Battery Life:	400 Hours (approximate)
Auto Shut-Off:	4-6 Minutes
Sensor Resolution:	0.5 inch per 4 foot (12.7mm/1.22m)
Measuring Range:	0 to 999,999.9 (Feet, Yds., Meters)
Wheel Accuracy:	99.5%
Speed Limit	8 mph
Display Capacity:	999,999.9 (7 digits)
Internal Math Accuracy:	10 digits
Operating Temperature:	-10°C (14°F) – 60°C (140°F)
Length (Extended):	
One Meter Wheel	45 inches L (1143mm)
Length (Contracted):	
One Meter Wheel	29 inches L (737mm)
Weight:	3 lbs 5oz without Stand 4 lbs 2oz with Stand
Wheel Size (Circumference):	
One Meter (standard)	
Two Foot (optional, sold separately)	
Three Foot (optional, sold separately)	

Repair and Return

Return Guidelines

1. Please read the **Warranty** in this User's Guide to determine if your Calculated Industries product remains under warranty **before** calling or returning any device for evaluation or repairs.
2. If your product won't turn on, check the batteries as outlined in the User's Guide.
3. If you need more assistance, please go to the website listed below.
4. If you believe you need to return your product, please call a Calculated Industries representative between the hours of 8:00am to 4:00pm Pacific Time for additional information and a Return Merchandise Authorization (RMA).

Call Toll Free: 1-800-854-8075

Outside USA: 1-775-885-4900

www.calculated.com/warranty

WARRANTY

Warranty Repair Service – U.S.A.

Calculated Industries (“CI”) warrants this product against defects in materials and workmanship for a period of one (1) year from the date of original consumer purchase in the U.S. If a defect exists during the warranty period, CI at its option will either repair (using new or remanufactured parts) or replace (with a new or remanufactured calculator) the product at no charge.

THE WARRANTY WILL NOT APPLY TO THE PRODUCT IF IT HAS BEEN DAMAGED BY MISUSE, ALTERATION, ACCIDENT, IMPROPER HANDLING OR OPERATION, OR IF UNAUTHORIZED REPAIRS ARE ATTEMPTED OR MADE. SOME EXAMPLES OF DAMAGES NOT COVERED BY WARRANTY INCLUDE, BUT ARE NOT LIMITED TO, BATTERY LEAKAGE, BENDING, A BLACK “INK SPOT” OR VISIBLE CRACKING OF THE LCD, WHICH ARE PRESUMED TO BE DAMAGES RESULTING FROM MISUSE OR ABUSE.

To obtain warranty service in the U.S., please go to the website.

A repaired or replacement product assumes the remaining warranty of the original product or 90 days, whichever is longer.

Non-Warranty Repair Service – U.S.A.

Non-warranty repair covers service beyond the warranty period, or service requested due to damage resulting from misuse or abuse.

Contact Calculated Industries at the number listed above to obtain current product repair information and charges. Repairs are guaranteed for 90 days.

Repair Service – Outside the U.S.A.

To obtain warranty or non-warranty repair service for goods purchased outside the U.S., contact the dealer through which you initially purchased the product. If you cannot reasonably have the product repaired in your area, you may contact CI to obtain current product repair information and charges, including freight and duties.

Disclaimer

CI MAKES NO WARRANTY OR REPRESENTATION, EITHER EXPRESS OR IMPLIED, WITH RESPECT TO THE PRODUCT’S QUALITY, PERFORMANCE, MERCHANTABILITY, OR FITNESS FOR A PARTICULAR PURPOSE. AS A RESULT, THIS PRODUCT, INCLUDING BUT NOT LIMITED TO, KEYSTROKE PROCEDURES, MATHEMATICAL ACCURACY AND PREPROGRAMMED MATERIAL, IS SOLD “AS IS,” AND YOU THE PURCHASER ASSUME THE ENTIRE RISK AS TO ITS QUALITY AND PERFORMANCE.

IN NO EVENT WILL CI BE LIABLE FOR DIRECT, INDIRECT, SPECIAL, INCIDENTAL, OR CONSEQUENTIAL DAMAGES RESULTING FROM ANY DEFECT IN THE PRODUCT OR ITS DOCUMENTATION.

The warranty, disclaimer, and remedies set forth above are exclusive and replace all others, oral or written, expressed or implied. No CI dealer, agent, or employee is authorized to make any modification, extension, or addition to this warranty.

Some states do not allow the exclusion or limitation of implied warranties or liability for incidental or consequential damages, so the above limitation or exclusion may not apply to you. This warranty gives you specific rights, and you may also have other rights, which vary from state to state.

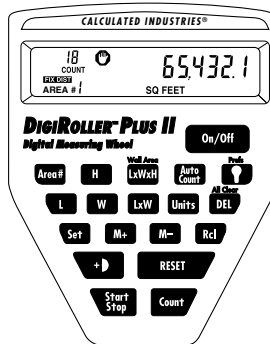

Um den *DigiRoller Plus II* fuer metrischen Masseneinheiten zu benutzen, druecken Sie bitte **[Set]** und dann **[Reset]** und **[Units]** zusammen. Das Geraet wird saemtliche Messungen im metrischen System vornehmen bis Sie die genannte Tastenkombination wieder druecken.



Der *DigiRoller Plus II* ist einzigartig unter den Messraedern, da die eingebaute Elektronik Messwerte speichern und manipulieren kann.

Hier ist eine Liste wichtiger Bedienungselemente:

On/Off

Ein-und-Ausschalter.

L

Laengentaste: Gemessen Laengenwerte koennen hier eingegeben und gespeichert werden.

W

Breitetaste: Gemessene Breitenwerte koennen hier eingegeben werden.

LxW

Flaechentaste: Brechnet und zeigt den Wert fuer die gerollte Flaechen an. (Multipliziert die Laenge mit der Breite.)

Units

Masseinheitentaste: Hier koennen die gewuenschten Masseinheiten ausgewaehlt werden. (Fuss-Zoll, Dezimalfuss, Dezimalzoll, Jards, Meter, und Morgen – auf der Anzeige) Durch druecken dieser Taste werden die Messwerte automatisch in die nachfolgende Einheit umgewandelt.

All Clear

DEL

Delete/All Clear Taste: Loescht die gespeicherten Werte fuer die als naechstes gedruckte Taste. Zum Beispiel: [DEL] [L] loescht den Wert der unter der Laengentaste gespeichert ist. [DEL] [W] loescht den Wert unter der Breitetaste, usw. Um den Speicher voellig zu entleeren (um alle Werte zu loeschen) druecken Sie bitte die folgende Kombination: [Set] [DEL] [DEL].

Rcl

Wiederherstellungstaste: Macht die DEL Funktion rueckgaengig und zeigt die letzten geloeschten Werte wieder an. Zum Beispiel: [Rcl] [W] zeigt den letzten geloeschten Wert fuer die Breite wieder an.

M+

Speichertaste: Mit M+ koennen gemessene Werte in den Hauptspeicher eingegeben werden. Beachten Sie bitte das nur Messungen mit gleichen Masseinheiten in den Speicher eingegeben und addiert werden koennen. (Zum Beispiel koennen Sie nicht Fuss-Zoll und Quadrat-Fuss zusammenrechnen.)

M-

Loeschtaste fuer den Speicher: Loescht den Wert der nachfolgenden Taste aus dem Speicher.

Set

Settaste: um spezielle Funktionen Abzurufen

+ R

Addition-Rad-Radiustaste: Beim einmaligen druecken dieser Taste wird der Radius des Rollrades automatisch zu den gemessen Werten addiert. Beim zweimaligen druecken wird der Durchmesser dazugerechnet. Diese Funktion ermoeoglicht das Kalkulieren von exakten Laenge oder Breiten von Wand-zu-Wand-Messungen.

RESET

Reset/Clear Display Taste: Setzt die Anzeige zurueck auf Null ohne den Inhalt des Hauptspeichers zu loeschen.

**Start
Stop**

Start/Stop Taste: Betaetigen Sie diese Taste um vorangegangene Messungen fortzufuehren oder druecken Sie [Reset] um wieder von Null zu beginnen.

Count

Manuelle Zaehltaste: Jedesmal wenn diese Taste gedrueckt wird zeigt das Display die Anzahl der Manuellen Betaetigung der Zaehltaste an. Diese Nummer wird in der oberen linken Ecke angezeigt. Das Geraet zaehlt von 1-199 und faengt dann wieder von vorn an. Wenn Sie die [Rcl] [Count] Tasten druecken koennen Sie totale Summe der Manuellen Betaetigung ablesen. (z.B. 203) Die Summe kann an der rechten Seite des Displays abgelesen werden.

Area#

Multiple Area Storage Key: Mit dieser Taste koennen bis zu Neun verschiedene Raumflaechen (Laenge x Breite) eingespeichert werden. Nachdem der erste Eintrag erfolgt ist, koennen durch das druecken dieser Taste zusaetzliche Werte eingegeben werden. Die Gesamtzahl der gespeicherten Messunge kann Neun Messungen nicht ueberschreiten. Diese Taste dient auch als Schalter um die eingespeicherten Werte abzurufen.

 H

Height: Speichert eine festgesetzte Hoehe oder eine gemessene (gerollte) Hoehe fuer die Berechnung von Kubik-Volumen und Wandflaechen. Diese Hoehenangabe wird automatisch in die naechste Volumenberechnung des folgenden Raumes einbezogen, es sei denn der Benutzer aendert diesen Wert.

Wall Area

 LxWxH

Volumen: berechnet das Volumen von eingegebenen oder gerollten Laengen, Breiten und Hoehenwerten.

 Auto
Count

AutoCount Mode: Schaltet das Geraet in “Auto-Count.” Dadurch koennen Sie eine bereits festgesetzte Entfernung in die Berechnung mit einbeziehen. Der DigiRoller Plus II zaehlt automatisch wie oft die eingegebene Entfernung erreicht wird. (z.B. Das Geraet zaehlt wie oft Sie 5 Fuss messen)



Schaltet das Displaylicht ein oder aus.

So setzen Sie den Metric-Modus

1. Schalten Sie das Gerat ein.

 On/Off

2. Drucken Sie die Taste [Set].

 Set

3. Drucken Sie die Taste [On/Off].

 On/Off

4. Halten Sie gedruckt die Taste [Reset].

 RESET

5. Drucken Sie die Taste [On/Off] bei der gedruckten Taste [Reset].

 RESET On/Off

6. Drucken Sie die Taste [Rcl], um in den Metric-Modus zu gelangen.

 Rcl

*Drucken Sie die Taste [LxW], um in den Imperial-Modus zu gelangen.

 LxW

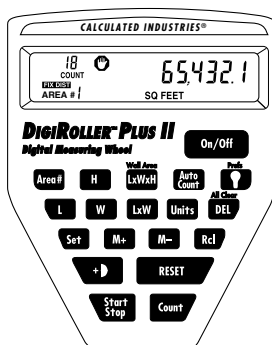

La *DigiRoller™ Plus II* est une roue à mesurer unique en son genre; en effet, elle est munie de touches qui permettent d'archiver et d'effectuer des calculs sur les distances mesurées.



Pour utiliser le mode de mesure métrique, appuyer sur [Set], puis sur [Reset] et [Units] à la fois. La *DigiRoller™ Plus II* prendra les mesures en unités métriques jusqu'à ce que cette combinaison de touches soit pressée à nouveau.

Voici la liste des touches servant à faire fonctionner la roue à mesurer :

On/Off

Power On/Off — Sert à allumer ou à éteindre l'unité.

L

Length — Permet d'entrer et d'archiver la valeur mesurée de la longueur.

W

Width — Permet d'entrer et d'archiver la valeur mesurée de la largeur.

LxW

Area — Calcule et affiche l'aire mesurée. Multiplie la valeur de la longueur entrée par la valeur de la largeur entrée.

Units

Units — Permet de sélectionner le format d'unité voulu : pieds/pouces, pieds décimaux, pouces décimaux, verges, mètres et acres (affichage de l'aire seulement). Chaque fois que cette touche est pressée, la mesure affichée est convertie à un autre format d'unité.

All Clear**DEL**

Delete/All Clear — Supprime ou efface les valeurs archivées dans la prochaine touche pressée (ex. : [DEL] [L] supprimera la valeur courante de longueur archivée, [DEL] [W] supprimera la valeur courante de largeur archivée, etc.). Pour effacer toutes les valeurs archivées, appuyer sur [Set] [DEL] [DEL]. Cette séquence de touches effacera toutes les données archivées et tous les registres de mémoire.

Rcl

Recall — Mémorise et affiche la valeur de la prochaine touche pressée (ex. : [Rcl] [W] affiche la valeur archivée dans la touche Width). [Rcl] [Rcl] réaffichera ou annulera l'effacement d'une valeur mesurée qui avait été effacée ou supprimée.

M+

M+ — Archive toute valeur affichée dans la mémoire permanente. Lorsqu'une valeur est placée en mémoire, elle s'ajoute aux valeurs déjà dans la mémoire. À noter qu'il est impossible d'additionner deux mesures comportant des unités exprimant des dimensions différentes (ex. : il est impossible d'additionner des pieds/pouces et des pieds carrés).

M-

M- — Soustrait la valeur affichée de la mémoire permanente.

Set

Set — Est utilisée pour accéder à des fonctions spéciales.

+ $\frac{1}{2}$

Add Wheel Radius — Additionne le rayon de la roue (appuyer 1 fois) ou son diamètre (appuyer 2 fois) à la mesure linéaire totale. Ainsi, la distance mesurée de mur à mur est exacte.

RESET

Reset/Clear Display — Remet l'affichage à 0. N'efface toutefois pas les valeurs archivées.

**Start
Stop**

Start/Stop — Cette touche permet de basculer l'unité entre les modes de départ et d'arrêt. Appuyer sur cette touche pour commencer à mesurer. En mode d'arrêt, un indicateur de panneau d'arrêt (🛑) sera affiché, et l'unité arrêtera de mesurer. Appuyer sur [**Start/Stop**] pour reprendre la mesure là où elle a été arrêtée, ou appuyer sur [**RESET**] pour repartir de zéro.

Count

Manual Count — Chaque fois que cette touche est pressée, l'unité affiche le compte dans le coin supérieur gauche de l'écran. L'unité comptera de 1 à 199, puis recommencera son compte à partir de 1. Toutefois, le fait d'appuyer sur [**Rcl**] [**Count**] affichera le total cumulé (ex. : 203) du côté droit de l'écran. Appuyer sur [**Del**] [**Count**] pour remettre le compte à zéro.

Area#

Multiple Area Storage — Cette touche permet d'archiver l'aire (longueur et largeur) de jusqu'à neuf pièces différentes. Une fois les premières valeurs d'aire archivées, presser cette touche pour archiver des valeurs supplémentaires, jusqu'à concurrence de neuf fois. Cette touche sert également à basculer entre les mesures d'aire des différentes pièces.

 H

Hauteur — Emmagazine une valeur de hauteur (mesurée ou entrée manuellement) pour calculer des volumes et des surfaces murales. La valeur de la hauteur sera reportée à l'aire de la prochaine pièce, à moins que l'utilisateur n'entre une valeur différente.

Wall Area

 LxWxH

Volume — Calcule les mesures de volume à partir des valeurs de longueur, de largeur et de hauteur mesurées ou entrées manuellement.

 Auto Count

Mode de comptage automatique — Place l'unité en mode <<AutoCount>> permettant ainsi de programmer une distance fixe qui sera automatiquement comptée avec chaque occurrence. La *DigiRoller™ Plus II* incrémentera automatiquement le compte chaque fois qu'elle arrive à la distance entrée par l'utilisateur (ex. : 1 unité comptera le nombre de fois que la distance de 5 pieds est mesurée) et affichera dans le coin supérieur gauche de l'écran le nombre de fois qu'elle aura mesuré ladite distance.



Éclairage — Allume ou éteint l'éclairage de l'écran.

Pour choisir le mode métrique

1. Mettre l'appareil sous tension.



2. Appuyer sur la touche [Set].



3. Appuyer sur la touche [On/Off].



4. Enfoncer la touche [Reset] sans la relâcher.



5. Appuyer sur la touche [On/Off] tout en maintenant la touche [Reset] enfoncée.



6. Appuyer sur la touche [Rcl] pour choisir le mode métrique.



* Pour choisir les mesures américaines, appuyer sur la touche [LxW].



Presentación de las Teclas y Definiciones (Spanish)

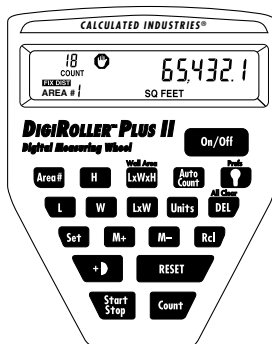

La *DigiRoller Plus II* es única entre las ruedas de medir porque tiene teclas que permiten memorizar y manipular las distancias medidas.



Para usar la Modalidad Métrica de Medir, presione [Set], [Reset] y [Units] al mismo tiempo. La *DigiRoller Plus II* mide en unidades Métricas hasta que vuelva a presionar las teclas.

La siguiente es una lista de las teclas que puede usar mientras opera la unidad.

On/Off

Tecla de prender/apagar — Prende o apaga la unidad.

L

Tecla de longitud — Entra y memoriza el valor de lo largo ya medido.

W

Tecla de Anchura — Entra y memoriza el valor de anchura ya medido.

LxW

Tecla de Área — Calcula y visualiza el área ya medido. Multiplica el valor de la longitud entrado por el valor de anchura entrado.

Units

Tecla de Unidades de Medir — Selecciona el formato de la unidad deseado: Pies-Pulgadas, Pies Decimales, Pulgadas Decimales, Yardas, Metros, y Acres (Visualización de Pantalla solamente). Cada presión de esta tecla convierte la medida visualizada a otro formato.

All Clear

DEL

Tecla de Despejo Total — Borra los valores memorizados en la siguiente tecla presionada (p.e., [DEL] [L] borra la medida memorizada actualmente como lo largo, [DEL] [W] borra la medida actual como la anchura, etc). Para borrar todo, presione [Set] [DEL] [DEL]. Esta secuencia de teclado borra todo los datos memorizados y los registros de memoria.

Rcl

Recuperar — Recupera los valores almacenados en cualquier registro (por ejemplo, pulse [Rcl] y luego la tecla de la que desee visualizar su valor). [Rcl] [M+] visualiza el contenido de la memoria.

M+

Memoria Más — Almacena el valor visualizado en pantalla en la memoria semipermanente. También suma el valor en pantalla a cualquier valor que se haya almacenado previamente en la memoria. Para traer a la pantalla el total almacenado en la memoria, pulse [Rcl] antes de [M+].

M-

Memoria Menos — Resta de la memoria el valor visualizado en la pantalla.

Set

Tecla de Ajuste — Se usa para acceder funciones especiales.

+ $\text{\textcircled{R}}$

Tecla de Sumar el Radius — (Primera presión) Suma el radius o diametro de la rueda (Segundo Presión) a la medida linear total, para permitir una distancia verdadera de pared a pared.

RESET

Tecla de Reajuste/y de Despejar — Regresa la visualización a 0. No borra los valores gurdados.

**Start
Stop**

Tecla de Empezar/Parar — Presione [Start/Stop] para continuar midiendo desde donde se quedó, o [RESET] para comenzar desde 0.

Count

Tecla de Área — Cada vez que se presiona esta tecla, la unidad indica la cuenta arriba y a la izquierda de la pantalla. La unidad cuenta del 1 a 199, y despues regresa a contar del 1. Sin embargo, si presiona [Rcl] [Count], el total acumulado se visualiza por ejemplo, 203) al lado derecho de la pantalla. Presione [Del] [Count] para regresar la cuenta a cero.

Area#

Tecla de Memorizar Área Multiple — Por cada uno de los 9 registros de número de área, puede memorizar la longitud, la anchura, la altura, el área, el volumen, y area de pared.

 H

Altura — Memoriza una distancia establecida de altura ya medida para calcular el volumen cúbico y el área de la pared. El valor de la altura se traslada al siguiente área del registro, a no ser que se cambie por el usuario.

Wall Area

 LxWxH

Volumen — Calcula medidas de volumen de los valores de la longitud, la anchura y de la altura entrados o memorizados.

 Auto
Count

Modalidad Autocontador — Coloca la unidad en “Autocontador”, permite la programación de una distancia fija que se cuenta con cada ocurrencia.



Tecla de Luz — Prende o apaga la luz de atrás de la pantalla.

Para seleccionar la modalidad métrica

1. Encienda la unidad.

 On/Off

2. Oprima la tecla [Set].

 Set

3. Oprima la tecla [On/Off].

 On/Off

4. Mantenga oprimida la tecla [Reset].

 RESET

5. Oprima la tecla [On/Off] mientras continúe oprimiendo la tecla [Reset].

 RESET On/Off

6. Oprima la tecla [Rcl] para activar la modalidad métrica.

 Rcl

*Oprima la tecla [LxW] para activar la modalidad del sistema imperial (sistema inglés).

 LxW

FCC CLASS B

This equipment has been certified to comply with the limits for a Class B calculating device, pursuant to Subpart J of Part 15 of FCC rules.

LOOKING FOR NEW IDEAS

Calculated Industries, a leading manufacturer of special function calculators and digital measuring instruments, is always looking for new product ideas in these areas.

If you have one, or if you have any suggestions for improvements to this product or its User's Guide, please call or write our Product Development Department. Thank you



DigiRoller™ Plus II

is a trademark of Calculated Industries, Inc.

ALL RIGHTS RESERVED.

Calculated Industries® is a registered trademark.

Designed in the United States of America

by Calculated Industries, Inc.

©2007, Calculated Industries, Inc.

4840 Hytech Drive • Carson City, NV 89706 U.S.A.

1-775-885-4900 • Fax: 1-775-885-4949

Tech Support Line: 1-775-885-4975

E-mail: techsup@calculated.com

www.calculated.com



**CALCULATED
INDUSTRIES®**

Putting answers at your fingertips since 1978

Designed in the United States of America
Printed in China

8/07



UG6425EFGS-D