

# MSA Type I Protective Helmet

## warnings, cautions, and instructions

### WARNING

THESE INSTRUCTIONS MUST BE CAREFULLY READ BY ALL INDIVIDUALS WHO WEAR OR MAINTAIN THIS HELMET, INCLUDING THOSE WHO HAVE ANY RESPONSIBILITY INVOLVING THE SELECTION, APPLICATION, USE OR REPAIR OF THIS HELMET. THE HELMET WILL PERFORM AS DESIGNED ONLY IF IT IS USED AND MAINTAINED ACCORDING TO THE INSTRUCTIONS. OTHERWISE, IT COULD FAIL TO PERFORM AS DESIGNED, AND PERSONS WHO RELY ON THIS PRODUCT COULD SUSTAIN SERIOUS PERSONAL INJURY OR DEATH.

The warranties made by Mine Safety Appliances Company with respect to this product are voided if there is confusion concerning specific conditions which may limit the helmet's protective capabilities, immediately contact your supervisor or safety director. Save this bag for future reference. If you have any questions or require additional information, please call: 1-800-MSA-2222, or write: MSA, P.O. Box 426, Pittsburgh, PA 15230.

If, after reading these instructions, there is ANY doubt as to the degree of protection offered by this helmet, or if there is confusion concerning specific conditions which may limit the helmet's protective capabilities, immediately contact your supervisor or safety director. Save this bag for future reference. If you have any questions or require additional information, please call: 1-800-MSA-2222, or write: MSA, P.O. Box 426, Pittsburgh, PA 15230.

### WARNING

FAILURE TO FOLLOW THE WARNINGS LISTED BELOW CAN RESULT IN SERIOUS PERSONAL INJURY OR DEATH.

- This Type I helmet provides LIMITED impact and penetration protection to the top of the head.
- MSA Type I helmets are not specifically designed to protect against lateral blows from the front, side, or rear. MSA's lateral protective helmets are so designed and MUST be used if lateral protection is desired. For more information, contact MSA. This helmet meets or exceeds the applicable requirements for a Type I helmet (top impact) as outlined in ANSI Z89.1 1997 and in most circumstances should be effective against small tools, bolts, rivets, sparks, and similar hazards; however, some conditions can exceed this helmet's capacity to protect against serious injury or death. AVOID areas where the chance of severe helmet impact or penetration exist.
- Class G (formerly Class A) and E (formerly Class B) helmets provide LIMITED electrical protection as outlined in the ANSI Z89.1, 1997 Standard. Sample helmets are proof tested to 2,200 volts (RMS) for Class G and 20,000 volts (RMS) for Class E, but these should NOT be construed as safe contact voltages.
- In order to provide maximum protection, the helmet MUST fit securely on the head and the headband MUST be adjusted to a snug fit. Always wear helmet so that nape strap (suspensions adjustment) is at rear of head; otherwise, reduced protection MAY result particularly if the helmet is worn tilted back. If you prefer to wear the helmet with the brim backwards, reverse the suspension so that the nape strap remains at the rear of the head. Although properly adjusted, some conditions such as high wind or helmet impact can dislodge the helmet from the head. To provide LIMITED additional retention capability, wear a chinstrap.
- Although it may provide limited head protection in the event of a fall, this helmet IS NOT designed for fall protection.
- NEVER use this helmet as a vehicular or sports helmet.
- NEVER store gloves, cigarettes, earplugs, etc. between the suspension and the shell. This space is needed when the shell suspension absorbs the energy of an impact. Objects in this space can transmit large forces to the head and neck, resulting in serious injury or death.
- Inspect the helmet before and after EACH use. ALWAYS follow the inspection procedure on this bag. Replace ANY part showing wear or damage.
- NEVER exceed useful service life guidelines of helmet as outlined on this bag. Replace components or helmet as required.
- NEVER alter or modify this helmet in ANY way. Use ONLY MSA supplied or approved accessories with the helmet. It is permissible to use pressure sensitive identification decals or Velcro on the helmet as long as they ARE NOT closer than 1/2 inch from the edge of the helmet. Modifications, or use of other than MSA accessories, can reduce the protection levels or dielectric properties (if applicable) designed into the helmet.
- NEVER use paint, solvents, or hydrocarbon type cleaners (e.g. M.E.K., thinner, gasoline, kerosene) on this helmet. These substances can damage the helmet materials in a manner which MAY NOT be visible to the user, causing the helmet to fail. Certain paints contain solvents which can damage parts of the helmet assembly.

### CAUTION

- This helmet MUST be stored in a clean, dry area where it is not exposed to extremes of heat or cold which can affect the helmet's useful service life.
- Clean with a mild soap and warm water to help avoid skin irritation from wearing the helmet.
- Even though sample helmets are proof tested to 2,200 V. for Class G and 20,000 V. for Class E, the maximum voltage against which the helmet will protect the wearer depends upon a number of variable factors, such as the characteristics of the electrical circuit, the care exercised in the maintenance of the helmet and weather conditions. The safe and proper use of the helmet in electrical applications should be established by the authority having jurisdiction and their recommendations MUST be strictly followed.

### HELMET DESCRIPTION

This helmet meets the requirements of the ANSI Z 89.1, 1997 Standard for protective headwear for industrial workers. The ANSI electrical insulation classification listed below is indicated on the label inside the helmet.

Class G (formerly Class A) - Tested to 2,200 volts  
Class E (formerly Class B) - Tested to 20,000 volts  
Class C - Not tested

This helmet is certified by the Safety Equipment Institute (SEI).

This helmet is a system consisting of a shell and suspension which work together as a unit. An optional chinstrap is available that works with the suspension to provide additional helmet retention. Since it is a system, each part must be kept in good condition to provide protection. This helmet is designed to provide LIMITED impact and penetration protection to the wearer's head in the event of a blow to the top of the head. Class G and E helmets are also designed to provide LIMITED electrical insulation protection. This helmet has been shipped with suspension disengaged from shell to prevent distortion during shipping. Install suspension as follows:

1. Set the helmet on its top.
2. Line up the suspension so that the sweatband is on the side of the cap with the letters MSA stamped on the brim.
3. Fold the clips up and out (Fig. 1) slotted; (Fig. 2) riveted.

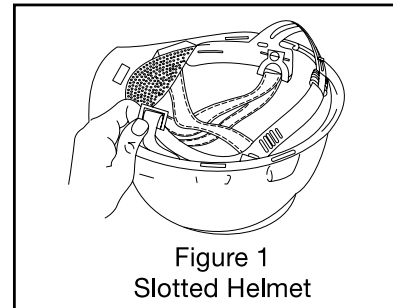

Figure 1  
Slotted Helmet

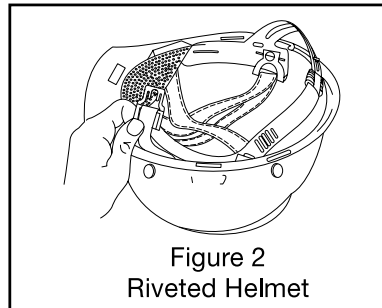

Figure 2  
Riveted Helmet

### Slotted Hats and Caps

4. Line up the clips with the slots. Push each of the four clips into its slot (Fig. 3). You should feel and hear them snap into place.

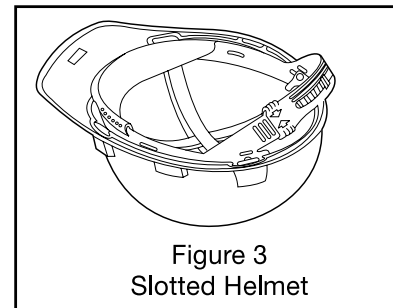

Figure 3  
Slotted Helmet

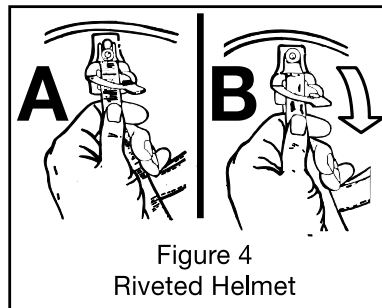

Figure 4  
Riveted Helmet

### Riveted Hats and Caps

5. Line up the clips with the studs. One at a time, slide the two prongs on the clip under the stud (Fig. 4A). Grasp webbing firmly approximately 2" below the metal clip and pull in a downward direction until you hear or feel the clip snap into place (Fig. 4B).

### CAUTION

- Do not pull on the headband during installation. Pull on the webbing only, otherwise damage may occur to the suspension.

### WARNING

- Do not mix suspension and helmet sizes. Make sure the sizes match (example: medium size suspension with medium size helmet).
- Use only MSA suspensions on an MSA helmet.
- Failure to comply with the above will reduce the energy absorbing ability of the protective helmet which can result in serious personal injury or death.

### INSTRUCTIONS FOR ADJUSTING SUSPENSION

FAS-TRAC® II RATCHET SUSPENSION  
U.S. Patent No. 5,950,245

1. Open ratchet band by turning knob counterclockwise as shown in Figure 5.
2. Push top crown strap toward crown of protective helmet; bottom crown strap will move in opposite direction (Fig. 8B).
3. Place helmet on head and push down on top of helmet until comfortable wearing height is reached.
4. Tighten ratchet band while on head by turning knob clockwise as shown in Figure 6. Tighten until comfortable fit is obtained.
5. To remove helmet, napestrap can be loosened while on head by repeating step one.

NOTE: Specific head sizes are not marked, however, the standard size ratchet suspension covers sizes 6 1/2 to 8 1/2.

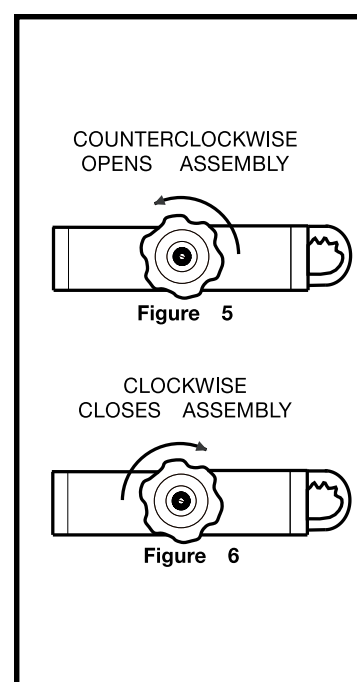

Figure 5

Figure 6

### FIXED-CROWN SUSPENSION (See Figure 7).

1. Adjust for head size by detaching wraparound tab on sweatband and repositioning "collar-button" in desired size marked on the band.
2. Push top crown strap toward crown of helmet; bottom crown strap will move in opposite direction (Fig. 8B).
3. Place helmet on head and push down on top until comfortable wearing height is reached.
4. Dual slots on the headband permit approximately 1/2 inch vertical adjustment to achieve comfortable position on the forehead; just move plastic tabs to desired slot.

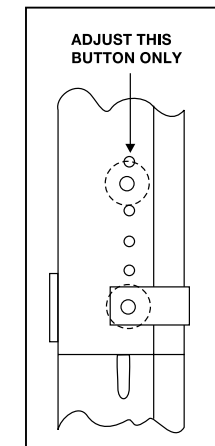
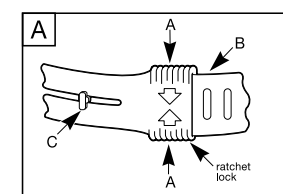

Figure 7

### STAZ-ON® SUSPENSION (See Figure 8). U.S. Patent No. 5,896,586

1. Open napestrap adjustment to largest head size by squeezing the ratchet lock (per arrows "A" in illustration). Grasp telescoping portion of napestrap (arrow "B") and slide to maximum open position.



- \* Specific head sizes are not marked, however, the Staz-On suspension covers the following head size ranges: Small - 6 to 7 1/8, Medium - 6 1/2 to 8, Large - 7 to 8 1/2.

2. Push top crown strap toward crown of helmet; bottom of crown will move in opposite direction (Fig. 8B).

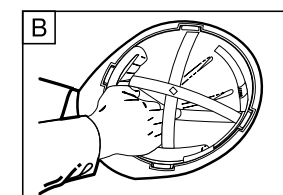

3. Place helmet on head and push down on top until comfortable wearing height is reached.

4. Place hands at back of head and grasp ratchet lock ("A" in illustration above) between right thumb and forefinger and then slide tab (C) with thumb of left hand (Fig. 8C).

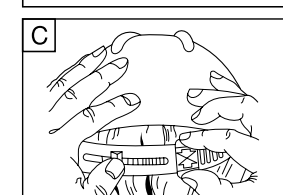

5. Pull ratchet (A) and slide tab (C) away from each other until comfortable fit is attained.



Figure 8

NOTE: To remove helmet, napestrap can be loosened while on the head by squeezing ratchet lock with left hand and pulling telescoping portion of napestrap with right hand.

### HELMET INSPECTION

The helmet's useful life can be affected by several things, including heat, cold, sunlight, and chemical exposures (See Useful Service Life Section). Before and after each use, inspect the helmet as follows:

#### Shell

Visually inspect the shell for breakage, cracks, craze pattern, discoloration, chalky appearance, or any other unusual condition. Also, inspect the shell for brittleness by flexing the brim. ANY of the above conditions can indicate a loss of impact, penetration and/or electrical

#### Suspension

Check for loss of flexibility of the suspension. Check for cracks, breaks, frayed straps or damaged stitching. If ANY are found, the suspension MUST be replaced IMMEDIATELY.

#### HELMET CARE

Helmets MUST be cleaned regularly to allow adequate inspection and to help the wearer to avoid skin irritation. Clean ONLY with Cleaner-Disinfectant Liquid (P/N 697284) from MSA, or mild soap (no detergents), and warm water.

#### USEFUL SERVICE LIFE GUIDELINES

THE USEFUL SERVICE LIFE BEGINS WHEN THE HELMET IS PLACED IN SERVICE.

This helmet was designed with high quality, wear resistant materials, but it WILL NOT last forever. The protective properties of the helmet WILL be degraded by exposure to many common work environments, such as temperature extremes, chemical exposure, UV radiation, and normal day-to-day wear and tear.

#### HELMET CARE

The user MUST inspect the helmet regularly (see Helmet Inspection section) and replace it or any part necessary. NEVER take a chance with your safety. In extreme exposure conditions, the helmet (or certain parts) may need to be replaced even if the helmet appears in good shape. MSA recommends the following replacement schedule:

- Suspension - Replace after NO MORE than 12 months.
- Entire Helmet - Replace after NO MORE than five years.

Remember that these are MAXIMUM useful service life guidelines. Wear or damage noticed during a regular inspection MUST be the determining factor for possible earlier replacement. In any case, ALWAYS replace the helmet after it has withstood impact or penetration.

# “Quality Helmets From the Leader In Head Protection”

Other products available. For additional information, please call MSA customer service 1-800-MSA-2222.

## ⚠ WARNING

- **KEEP THIS BAG AWAY FROM BABIES AND CHILDREN. DO NOT USE IN CRIBS, BEDS, CARRIAGES OR PLAY PENS. THE THIN FILM MAY CLING TO NOSE AND MOUTH AND PREVENT BREATHING.**
- **HELMET IS TO BE REMOVED FROM BAG ONLY BY THE END USER.**
- **ALL INSTRUCTIONS ON BOTH SIDES OF BAG MUST BE CAREFULLY READ AND FOLLOWED WITH SPECIAL ATTENTION TO ALL WARNINGS AND CAUTIONS.**

## WARRANTY

MSA warrants this product against defects in material and workmanship for 12 months from the date of purchase.

## UniPro™ Suspension for Medium Cap and Standard Hat

### INSTALLATION INSTRUCTIONS

The complete instructions procedure must be read and understood by the user before assembly and use. Refer to the instructions provided with the MSA helmet.

### INSTALLATION

1. Orient suspension assembly with nape strap toward back of helmet. (See Figure 1)
2. Suspension should be positioned with smooth side to the user. Push suspension clips into helmet lugs. You should hear them snap into place.
3. Assemble the Latch Connection by fastening the Latch and Snap together. (See Figure 2)
4. Orient the sweatband per Figure 3 and 4 with the white mesh as shown.
5. Insert two plastic arrowheads (on front of headband) into the foam sweatband slots (near the center). (See Figure 3)
6. Simply wrap the sweatband around the outside of the headband, and hook over lugs on each side of Headband. (See Figure 5)
7. Fold sweatband over crown of the headband suspension. The smooth foam (gray side) should be in contact with the users head.
8. Lace nape strap through plastic buckle and press button into hole estimated to your head size.

Adjust for comfort by moving pin. Adjust inward to tighten, outward to loosen.

### Inspection and Use Guidelines for UniPro Suspension

Visually inspect the suspension for breakage, cracks, craze pattern, discoloration, or any other unusual conditions. Check the suspension for brittleness by flexing. If ANY of these conditions are found, the suspension MUST be replaced IMMEDIATELY.

### V-Gard® Unipro Service Life

THE USEFUL SERVICE LIFE BEGINS WHEN THE HELMET IS PLACED IN SERVICE.

This helmet was designed with high quality, wear resistant materials, but it WILL NOT last forever. The protective properties of the helmet WILL be degraded by exposure to many common work environment, such as temperature extremes, chemical exposure, UV radiation, and normal day-to-day- wear and tear.

The user MUST inspect the helmet regularly (see Helmet Inspection section) and replace it or any part necessary. NEVER take a chance with your safety. In extreme exposure conditions, the helmet (or certain parts) may need to be replaced even if the helmet appears in good shape. MSA recommends the following replacement schedules:

**Suspension-** Replace after no more than 12 months  
**Entire Helmet-** Replace after no more than 5 Years

Wear of damage noticed during a regular inspection MUST be the determining factor for possible earlier replacement.

## ⚠ WARNING

- **Use this suspension only with medium size V-Gard® cap or standard size V-Gard® hat.**
- **DO NOT reverse the Unipro Suspension in the hard hat or wear the hard hat backwards.**

**FAILURE TO FOLLOW THESE WARNINGS CAN RESULT IN ALTERED HELMET PERFORMANCES AND MAY RESULT IN SERIOUS PERSONAL INJURY OR DEATH.**

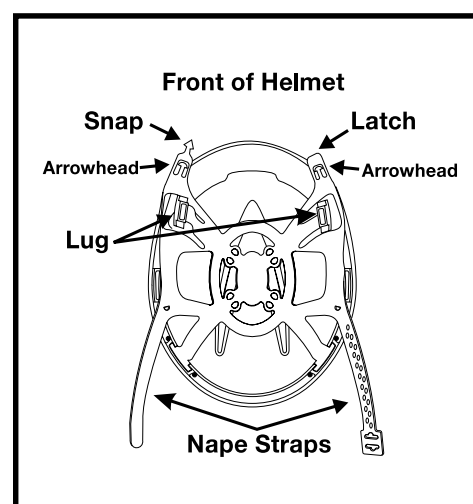

Figure 1

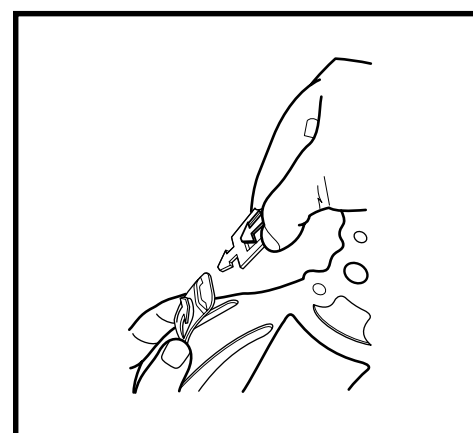

Figure 2

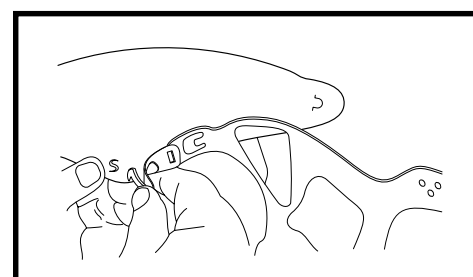

Figure 3

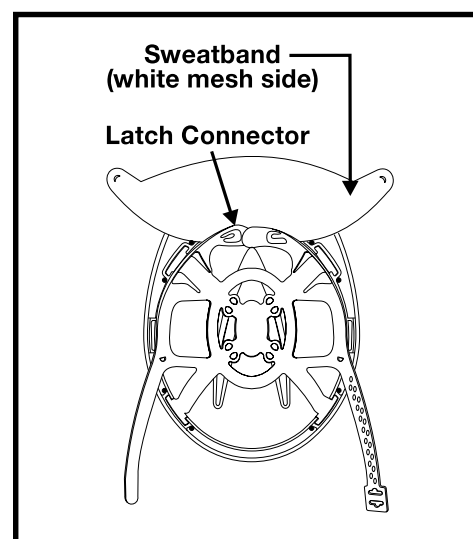

Figure 4

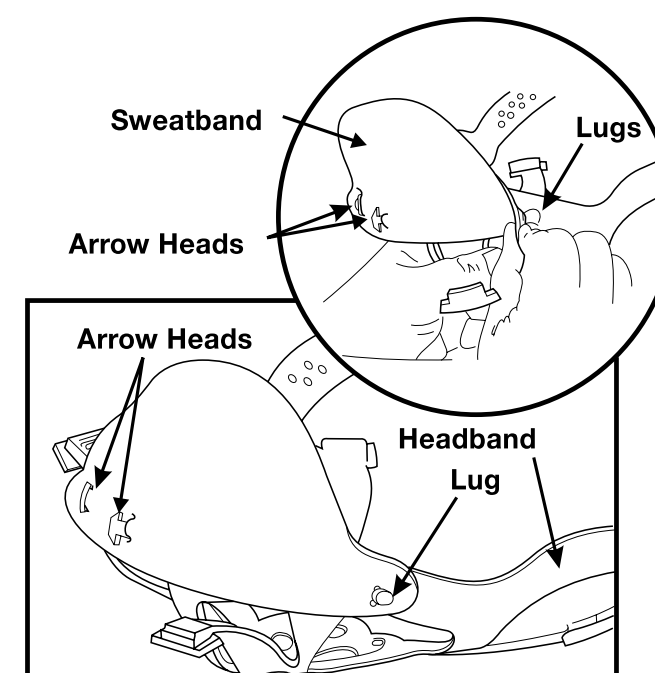

Figure 5

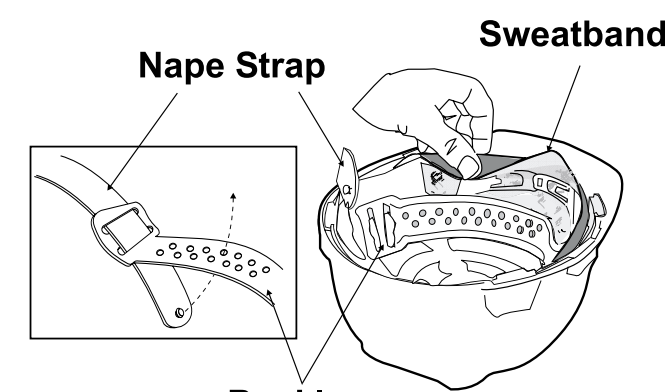

Figure 6

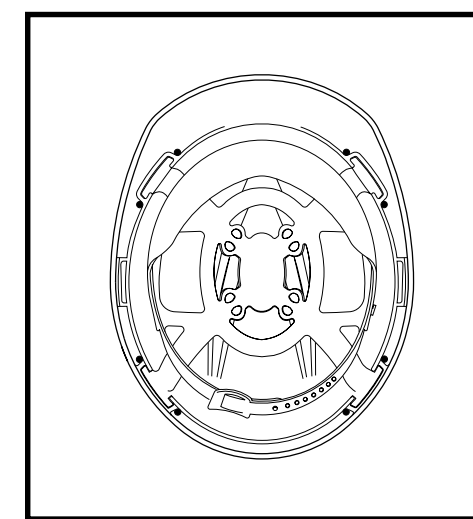

Figure 7

Manufactured by



**MINE SAFETY APPLIANCES COMPANY**  
PITTSBURGH, PENNSYLVANIA, U.S.A. 15230

009 (L) Rev. 8

816803