



US9465701 (01-08)

Operator's Manual & Spare Parts List 465 Stainless Steel Compression Sprayer



If you are missing parts, instructions or have questions, DO NOT take this unit back to the store. Call 1-800-SOLO-INC. Solo will send the missing parts/information to you promptly.

WARRANTY:

Solo model 465 sprayers are covered by Solo's 5-YEAR LIMITED WARRANTY. Solo manufactured parts, which fail due to defective material or workmanship, will be repaired or replaced without charge. See page 3 for full details.

SAFETY PRECAUTIONS:

- Do not fill with, use or spray flammable materials.
- Do not use gasoline, acid, caustic or potentially injurious chemicals.
- At the time of manufacture of this sprayer, we are not aware of any approved plant protection chemicals, which would adversely affect this sprayer when applied in their usual concentration.
- Observe the recommendations of the chemical manufacturer.
- **Prior to removing any part of the sprayer, squeeze the shut-off valve to release any pressure in the tank.**
- **Wear rubber gloves, safety goggles and appropriate protective clothing.**
- **After pumping, be sure handle is in the locked down position.**
- Individuals should be trained in the proper use of this sprayer. Where training is not available, individuals should study and follow the procedures detailed in this manual.



WARNING:

Chemicals can be harmful to individuals and the environment if improperly used. In addition, some chemicals are caustic, corrosive, or poisonous and should be avoided. Read warnings and chemical manufacturer's instructions. Solo sprayers are fitted with Viton® seals, which are resistant to a wide variety of agricultural and household chemicals; however, care should be exercised to ensure that sprayer components are clean, functioning properly, and in a good state of repair before and during use. If in doubt about a particular chemical, check with manufacturer. If you suspect or observe indications that the material may be unsafe in a Solo sprayer... **STOP!** Do not use or apply chemical.

ALWAYS WEAR RUBBER GLOVES, SAFETY GOGGLES AND APPROPRIATE PROTECTIVE CLOTHING.

- Read and follow operating instructions.
- Do not fill sprayer over maximum fill mark. Releasing pressure in an overfill condition can cause harmful venting of sprayer contents.
- Relieve pressure with sprayer upright.
- **CAUTION:** To prevent injury from ejected pump assembly and/or solution, never stand with face or body over the top of the tank when pumping, or loosening pump.
- Do not modify sprayer.
- Never spray in the direction of humans, animals or property which might be injured or damaged by spray formula.
- Do not use disinfectants, solvents or impregnating agents unless first tested to ensure they are not harmful to the environment and sprayer.
- Do not use liquids with a temperature above 110°F (43°C).
- Remember that a sprayer with liquid is a significant amount of weight (8 lbs. per gallon). Use caution when bending, leaning or walking. Bend only at the knees and support yourself as required to ensure personal safety.
- Do not inflate sprayer without liquid in the tank.
- Do not climb on ladders, trees or other unsteady or potentially unsafe structures while using sprayer.

Customer Service Commitment From Solo's Service Department

In the event the sprayer you have purchased has missing or damaged parts, please call 1-800-765-6462, 9:00 AM - 5:00 PM EST. In order to assist your service representative, please have the following information available: sprayer model number, part description and part number. A parts list is included in your operator's manual.

Solo is committed to your satisfaction and is continuing its efforts to earn your future business.

Visit us on the web at www.solousa.com

Parts ordering available on-line, or call Solo's order desk at (757) 245-5531.

Assembly Instructions for Wand

1. Ensure that the O-ring is on the non-threaded end of the wand.
2. Insert the non-threaded end of the wand with O-ring into the open end of the shut-off valve.
3. Tighten the screw cap.
4. Wand is fitted with a slide-retainer for easy storage.

Using the Brass Adjustable Nozzle

To change the spraying pattern, first make sure the retaining nut (1) is screwed tightly to the elbow (4). For a straight stream pattern, rotate the nozzle outward. For a hollow cone pattern, rotate the nozzle inward towards the retaining nut. If it becomes difficult to rotate the nozzle cap, remove the nozzle cap from the nozzle body and lubricate the O-ring on the nozzle body with non-water soluble grease. Solo lubricant #9850 is available.

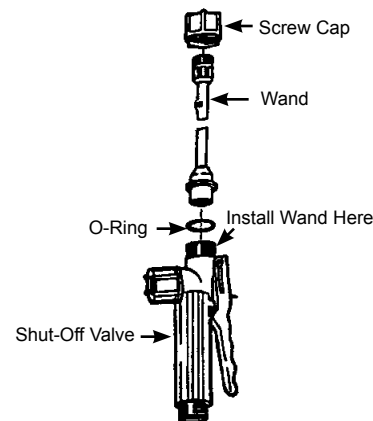

Operation:

1. Before using sprayer with chemicals, fill sprayer with fresh water to assure that you have it properly assembled; pressurize and then practice spraying. When thoroughly familiar with sprayer operation, follow normal operating procedures.
2. Turn pump handle counterclockwise to remove pump.
3. Fill tank with premixed formula up to desired level. Observe recommendations of chemical manufacturer.
4. Tighten pump assembly for a good seal.
5. Start or stop spraying by squeezing or releasing the lever on the shut-off valve. The spray pressure can be monitored with an optional pressure gauge part #4900622.
6. Prior to every removal of pump (1, see page 4), release pressure by spraying chemical into suitable container for later use.

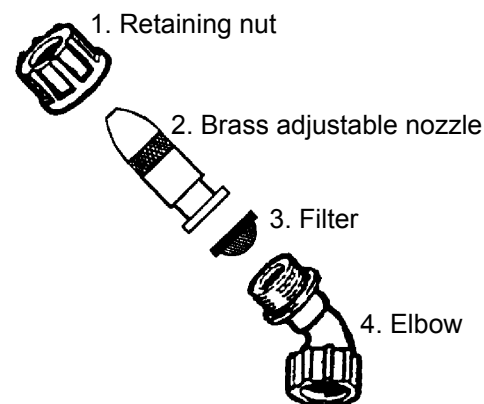

Cleaning:

1. Carefully clean sprayer after every use.
2. Soap and water may be used to clean tank.
3. Clean the hose and spray tube by flushing with water.
4. Follow the recommendations of the chemical manufacturer for disposing of waste-water and chemicals.
5. Do not use aggressive or abrasive cleaning agents.

CAN I USE WEED KILLER AND INSECTICIDE IN THE SAME SPRAYER?

In theory you can, if the sprayer is thoroughly cleaned out with a bleach/water solution of 1:25. In practice, the use of both types of chemicals in the same unit is not recommended as the risk to plants can be high. Use caution when handling any type of chemicals and when cleaning your sprayer. Do not mix cleaning agents as toxic reactions can result.

WHAT SPRAY NOZZLE SHOULD I USE?



A flat spray nozzle is supplied for spraying paths, garden beds, and general area spraying. A cone nozzle is also supplied for spot spraying and for the treatment of bushes and small trees. For spot spraying, simply remove swirl plate from behind nozzle tip. Save the swirl plate for future use. Available as an option is a reflux filter with a built-in check valve (27 00 316), which opens at 5 psi and closes at 4 psi. This virtually eliminates the dripping of fluid still contained in the spray wand. A wide selection of nozzles such as deflector, adjustable, and anti-drift nozzles are available.

CAN I DO SPOT SPRAYING?

The shut-off valve on the Solo sprayer is well-suited for spot spraying. It's almost effortless! The shut-off valve handle incorporates a clip, which holds the valve open for area spraying without tiring the operator's hand.

OPERATING FEATURES:

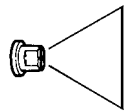
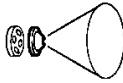
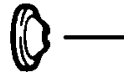
Nozzles - Your Solo sprayer is standard with nozzle arrangements to provide a variety of spray patterns.

Item	Application	Part #	Item	Application	Part #
 Flat spray nozzle	row treatment	4074263	 Jet stream nozzle and swirl plate= hollow cone	shrubs and bushes	4074755 4074756
 Jet stream nozzle	spot & longer range	4074755	 Brass adjustable nozzle	Spot, shrubs & bushes	4900207

Spray tips should be assembled as follows for desired spray patterns.

SPRAY TIP ASSEMBLY

1. Flat spray nozzle
 2. Filter
 3. Jet cap
 4. Swirl plate
 5. Nozzle cap
 6. Nozzle body
 7. Brass adjustable nozzle*
 8. Nozzle retaining nut
- *Brass adjustable nozzle is NOT a standard item on all Solo sprayers.

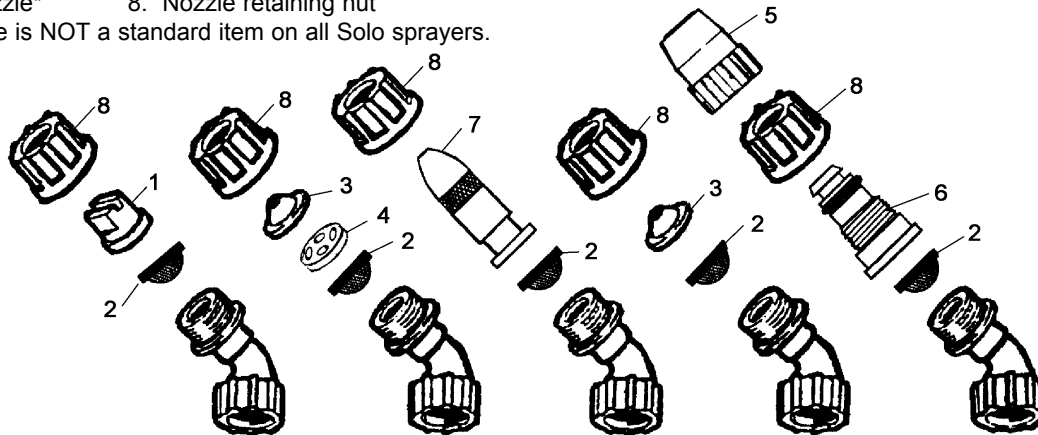

In the best interest of continued technological progress, we reserve the right to change design and configuration of any product without prior or other notice. Therefore, please note that text and illustrations of this manual are not to be considered binding and do not constitute a basis for legal or other claims.

SOLO LIMITED WARRANTY

Solo Incorporated guarantees the original purchaser of Solo equipment that any failure of Solo manufactured parts due to defects in material and workmanship occurring during the applicable warranty period will be repaired or replaced without charge for parts or labor, except for those items not covered by warranty.

CONSUMER LIMITED WARRANTY: Solo equipment purchased for consumer use is covered by this Limited Warranty for a period of FIVE (5) YEARS.

COMMERCIAL LIMITED WARRANTY: Solo equipment purchased for commercial use is covered by this Limited Warranty for a period of ONE (1) YEAR.

OPERATOR'S OBLIGATION AND RESPONSIBILITY: Proof of purchase must be provided by the owner in order to obtain warranty service. Should any failure covered by this Limited Warranty occur, deliver or ship the Solo products or parts to an authorized Solo service center. Freight, packing and insurance costs, if any, will be borne by the owner. Follow normal maintenance service to include applicable lubrication, operation and storage of the product as explained in the operator's manual.

ITEMS NOT COVERED BY WARRANTY: Provisions of the Limited Warranty will not apply to the following: any indirect or consequential damages that may result from the failure or malfunction of the Solo product. Normal service requirements arising during the warranty period, such as cleaning, normal wear, lubrication, filter, spray tips, etc. Normal service work over and above the repair or replacement of defective parts. Any failure that results from an accident, customer abuse, normal wear, neglect or failure to operate the product in accordance with the instructions provided in the operator's manual or provided with the product. When an alteration or modification has been performed on a Solo product, Solo is responsible only for products as originally furnished by Solo, provided the alterations or modifications do not adversely affect the product's operation, performance or durability. Parts or accessories that are incompatible with the product are not approved by Solo.

Full disclosure of Solo's Limited Warranty is available from your local Solo dealer or from Solo Incorporated, 5100 Chestnut Avenue, Newport News, Virginia 23605, (757) 245-4228.

SPARE PARTS LIST

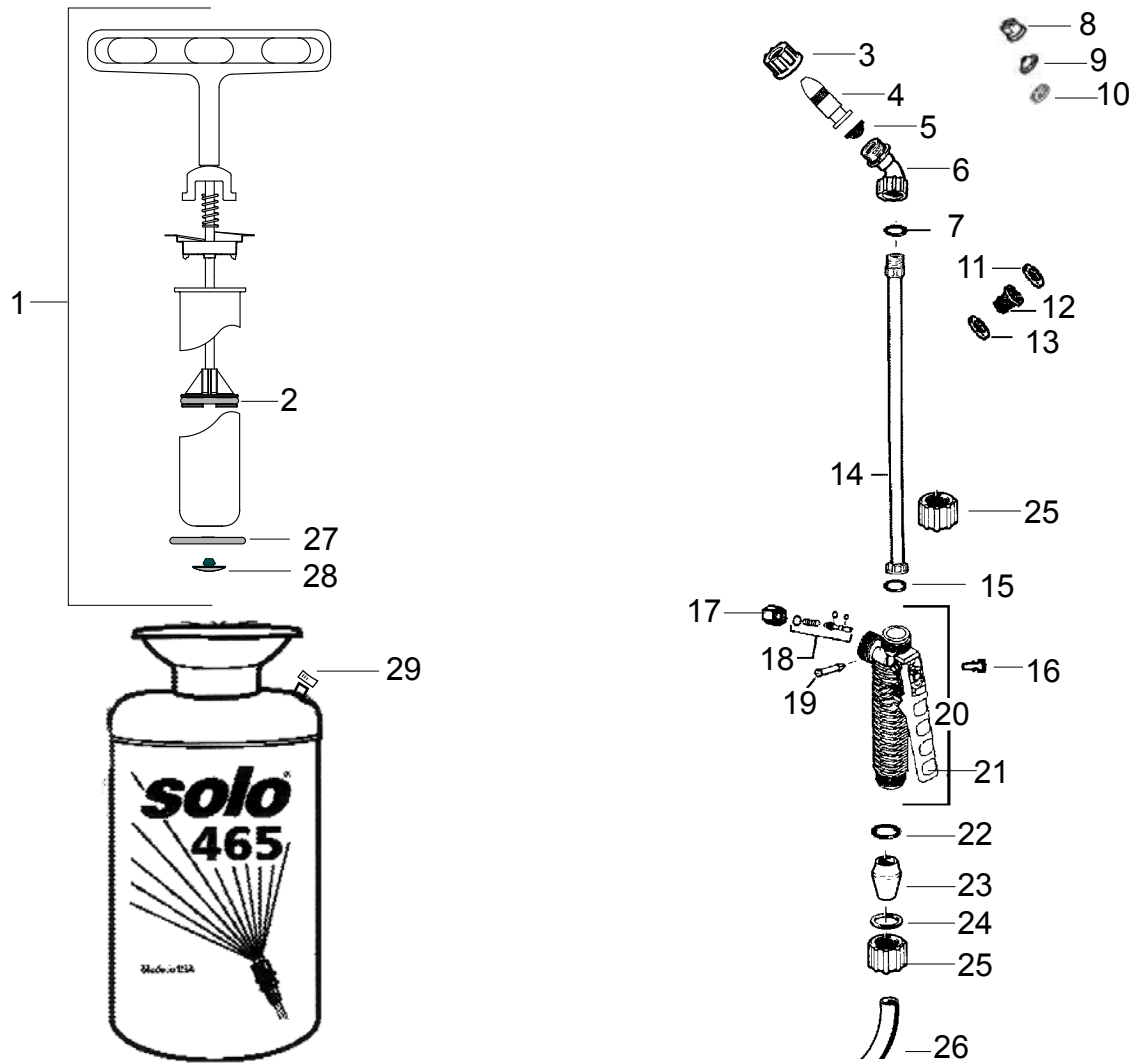

Position No.	Part No.	Description	Position No.	Part No.	Description
1	948461	Complete pump	18	0610402-K	Shut-off valve repair kit
2	805322	O-ring	19	4074295	Pin
3	4074148	Retaining nut	20	4800170	Shut-off valve
4	4900207	Brass adj. nozzle	21	4074335	Lever
5	4074283	Jet Filter	22	0062271	O-ring
6	4074527	Elbow	23	4074500	Clamp
7	0062115	O-ring	24	0031356	O-ring
8	4074263	Flat spray nozzle	25	4074337	Retaining nut
9	4074755	Jet cap	26	0064234	Hose (item 23, 24, 25 incl.)
10	4074756	Swirl plate	27	955860	Tank gasket
11	0062106	O-ring	28	151406	Check valve
12	2700316	No drip check valve	29	803612	Clamp
13	0062115	O-ring			
14	4900421	Brass wand (item 15, 25 incl.)			
15	0062258	Gasket			
16	4074329	Lock clip			
17	4074336	Retaining nut			

Order parts on-line at www.solousa.com or call Solo's order desk at (757) 245-5531. For service, contact Solo's Technical Service Department at (800) 296-7656.