

157840
157841
157842
157843
157845
157846

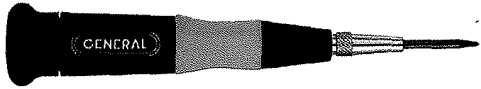

757087

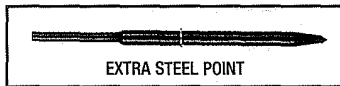

AUTOMATIC CENTER PUNCH

- For marking, punching, staking, and starting screw holes.
- One-hand spring impact operation, no hammer needed.
- Heat Treated high carbon steel point improves performance and increases life.

- One extra steel point included.
- Precision engineered 750 Series Versa-Grip™ handle for maximum performance.

UPC	NO.	PKG.
75978 8	757087	Carded

707088

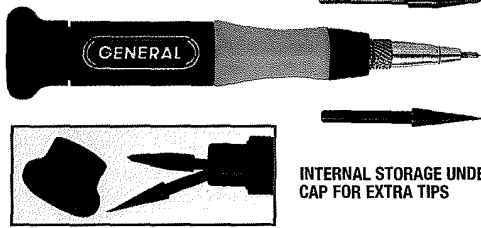

3-PIECE MARKING TOOL SET

- Used for marking, etching or engraving metal, glass, plastics and ceramics.
- Set includes: • One Multi-Purpose Handle assembly • One Steel Awl • One Tungsten Carbide Scribe • One Steel Scribe.
- Tungsten Carbide Point for etching hard materials.
- Steel Awl for marking and piercing.
- Steel Scribe for marking soft materials.

- Precision tolerance locking screw chuck holds steel point securely in place.
- Precision engineered 700 Series Versa-Grip™ handle for maximum performance.

UPC	NO.	PKG.
70708 6	707088	Carded

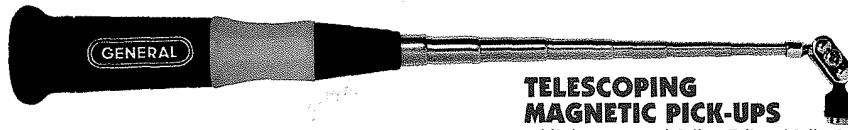

759383, 759394, 759398

TELESCOPING MAGNETIC PICK-UPS

- High powered 2 lb., 5 lb., 10 lb. Neodymium Magnet is 6 times stronger than standard Cobalt Magnets.
- Double ball joint connection permits infinite angle adjustments.
- High strength corrosion resistant stainless steel wand extends from 6-1/2" - 27" (165mm - 686mm).

- Magnet holder is constructed of high-strength reinforced nylon.
- Precision engineered 750 Series Versa-Grip™ handle for maximum performance.

UPC	NO.	PULL	PKG.
75933 7	759383	2 lb.	Carded
75958 0	759394	5 lb.	Carded
75939 9	759398	10 lb.	Carded

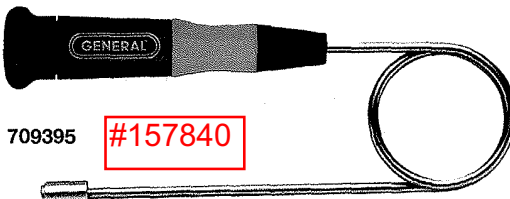

709395

BENDABLE SHAFT MAGNETIC PICK-UP - 2 LB. PULL

- High powered 2 lb. Neodymium Magnet is 6 times stronger than standard Cobalt Magnets.
- An excellent tool for retrieving steel parts from hard to reach places.
- Flexible aluminum shaft is 15" long.

- Precision engineered 700 Series Versa-Grip™ handle for maximum performance.

UPC	NO.	PKG.
70956 1	709395	Carded



709392

FIXED LENGTH MAGNETIC PICK-UP 2 LB. PULL

- No. 709392 has a 2 lb. smooth surface magnetic pull capacity with an overall length of 6-3/4" (171mm).
- High strength stainless steel shaft resists corrosion.

- Durable ball joint connection permits infinite angle adjustments.
- High powered Neodymium Magnet is 6 times stronger than standard Cobalt Magnets.

- Magnet holder is made of high-strength reinforced nylon.
- Precision engineered 700 Series Versa-Grip™ handle for maximum performance.

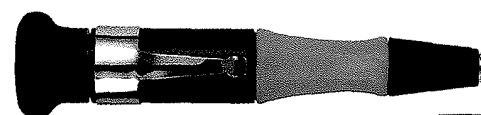

709386

POCKET MAGNETIC PICK-UP 2 LB. PULL

- No. 709386 has a 2 lb. smooth surface magnetic pull capacity with an overall length of 4" (100mm).

UPC	NO.	PKG.
70972 1	709392	Carded
70958 5	709386	Carded

DOUBLE BALL JOINT CONNECTION PERMITS INFINITE ANGLE ADJUSTMENTS

HIGH STRENGTH CORROSION RESISTANT STAINLESS STEEL TELESCOPING WAND

ERGONOMICALLY DESIGNED HANDLE WITH CONTOURED HEAD FOR GREATER CONTROL AND COMFORT

EIGHT SIDED CUSHION GRIP HAS A NON-SLIP SURFACE

RUGGED HIGH IMPACT ABS PLASTIC HANDLE

ROTATING CAP FACETS FIT PALM

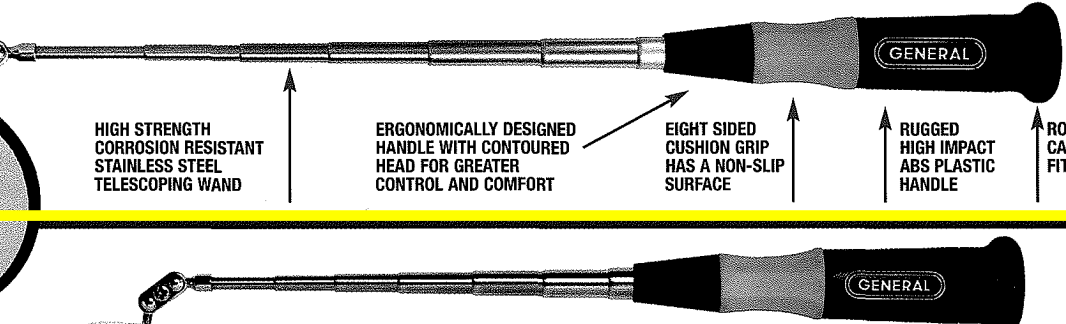
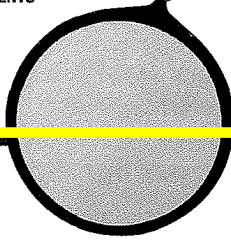

2-3/8"

#157841

759387

2-3/8" ROUND TELESCOPING 3X POWER MAGNIFIER

- Fine quality, 3x power, magnifier for Laboratory Technicians, Engineers, Mechanics and Inspectors.
- High clarity 2-3/8" (60mm) diameter acrylic lens resists shattering.

- High strength corrosion resistant stainless steel wand extends from 8-1/2" to 29" (216mm - 737mm).
- Precision engineered 750 Series Versa-Grip™ handle for maximum performance.

UPC	NO.	PKG.
75938 2	759387	Carded

2-1/2"

#157842

759563

2-1/2" ROUND TELESCOPING 3X POWER MAGNIFYING MIRROR

- For the inspection of obstructed and hard to see objects.
- High quality 2-1/2" (64mm) diameter magnifying glass mirror improves visibility.

- High strength corrosion resistant stainless steel wand extends from 8-1/2" to 29" (216mm - 737mm).
- Precision engineered 750 Series Versa-Grip™ handle for maximum performance.

UPC	NO.	PKG.
75959 7	759563	Carded

#157843

1-1/2"

759575

1-1/2" ROUND LEXAN™ TELESCOPING MIRROR

- For the inspection of obstructed and hard to see objects.
- High performance 1-1/2" (38mm) diameter Lexan™ mirror resists scratching and shattering.

- High strength corrosion resistant stainless steel wand extends from 7-5/8" to 28" (194mm - 711mm).
- Precision engineered 750 Series Versa-Grip™ handle for maximum performance.

UPC	NO.	PKG.
75957 3	759575	Carded

2" X 3" RECTANGULAR LEXAN™ TELESCOPING MIRROR

- For the inspection of obstructed and hard to see objects.
- High performance 2" x 3" (51 mm x 76 mm) rectangular Lexan™ mirror resists scratching and shattering.

- High strength corrosion resistant stainless steel wand extends from 9-1/4" to 30" (235mm - 762mm).
- Precision engineered 750 Series Versa-Grip™ handle for maximum performance.

UPC	NO.	PKG.
75950 4	759570	Carded

1-1/2"

70972 1

1-1/2" ROUND LEXAN™, FIXED LENGTH, INSPECTION MIRROR

- For the inspection of obstructed and hard to see objects.
- High performance 1-1/2" (38mm) diameter Lexan™ mirror resists scratching and shattering.

- High strength stainless steel shaft resists corrosion.
- Overall length is 8" (203mm).
- Precision engineered 700 Series Versa-Grip™ handle for maximum performance.

UPC	NO.	PKG.
70972 1	709575	Carded

TELESCOPING *Speed-Chuck™* INSPECTION SETS

- Stainless Steel *Speed-Chuck™* and telescoping wand combination provides quick and limitless inspection and retrieval solutions.
- Ergonomically designed handle with contoured head for greater control and comfort.
- Handle telescopes from 6-3/8" (163mm) to 26" (660mm).
- Spring-loaded *Speed-Chuck™* allows blade changes instantly.
- All attachments are fastened to a stainless steel *Speed-Chuck™* adapter with a double ball joint, adjusts safely protected with a zippered case.

- Precision Locking System firmly holds blades in place.
- Available attachments:
 - Neodymium magnets: 2 lb., 5 lb. and 10 lb. smooth surface pull capacities
 - Mirrors & Magnifiers: 1-1/2" (38mm) diameter
 - 2" x 3" (51mm x 76mm) rectangular mirror
 - 2-3/8" (60mm) dia. 3x power magnifying mirror
 - 2-1/2" (64mm) dia. 3x power magnifier;
 - Alligator Clip
 - Mini-Lite.

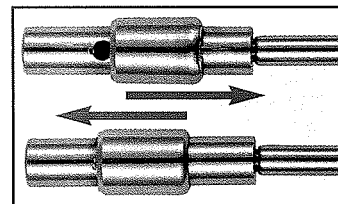

IM 523 201

1/2 page module
"Inspection Tools"
7 items

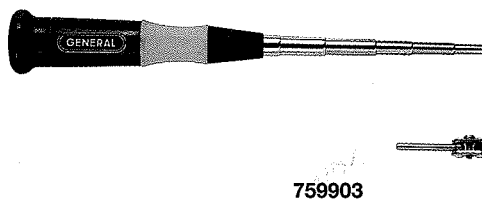

759903

5-PIECE TELESCOPING "SPEED-CHUCK™" INSPECTION SET

Set includes: • 26" Stainless Steel Telescoping Wand with *Speed-Chuck™* assembly • 2 lb. Magnetic Pick-Up • 2" x 3" Rectangular Lexan® Mirror • Mini-Lite. Batteries included. Precision engineered 750 Series Versa-Grip™ handle for maximum performance.

UPC	NO.	PKG.
75961 0	759905	Zippered Case/Boxed

- Set includes: • 26" Stainless Steel Telescoping Wand with *Speed-Chuck™* assembly • 5 lb. Magnetic Pick-Up • 2" x 3" Rectangular Lexan® Mirror • 3x Power Magnifier, Alligator Clip • Mini-Lite. Batteries included.
- Precision engineered 750 Series Versa-Grip™ handle for maximum performance.

UPC	NO.	PKG.
75961 0	759905	Zippered Case/Boxed

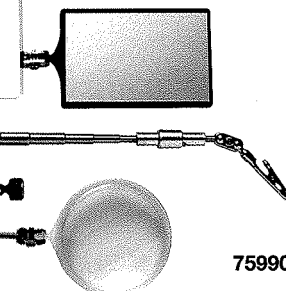

759905

5-PIECE TELESCOPING "SPEED-CHUCK™" INSPECTION SET

759909

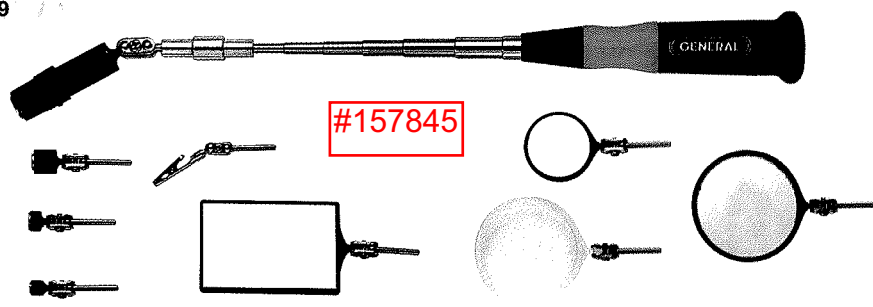

#157845

9-PIECE TELESCOPING "SPEED-CHUCK™" INSPECTION SET

Set includes: • 26" Stainless Steel Telescoping Wand with *Speed-Chuck™* assembly • 2 lb., 5 lb. and 10 lb. Magnetic Pick-Ups • 1-1/2" Round Mirror • 2" x 3" Rectangular Mirror • 2-1/2" Round Glass Magnifying Mirror • 3x Power Magnifier, Alligator Clip • Mini-Lite • Batteries included.

Precision engineered 750 Series Versa-Grip™ handle for maximum performance.

UPC	NO.	PKG.
75962 7	759909	Zippered Case/Boxed

2-PIECE TELESCOPING INSPECTION SET

Set includes:

- No. 759383 - 2 lb. Telescoping Magnetic Pick-Up (see page 4).
- No. 759575 - 1-1/2" (38mm) diameter Telescoping Mirror (see page 5).

- Convenient Ballistic Nylon Storage Holster.
- Precision engineered 750 Series Versa-Grip™ handle for maximum performance.

UPC	NO.	PKG.
75963 4	75902	Holster/Carded

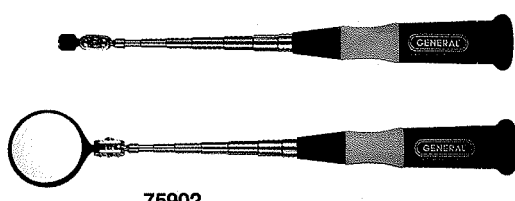

75902

3-PIECE TELESCOPING INSPECTION SET

Set includes:

- No. 759398 - 10 lb. Telescoping Magnetic Pick-Up (see page 4).
- No. 759570 - 2" x 3" (51mm x 76mm) Rectangular Mirror (see page 5).
- No. 580 "Lite-It" Clip-On Mini Light (see below).

- Convenient Ballistic Nylon Storage Holster.
- Precision engineered 750 Series Versa-Grip™ handle for maximum performance.

UPC	NO.	PKG.
75964 1	75903	Carded

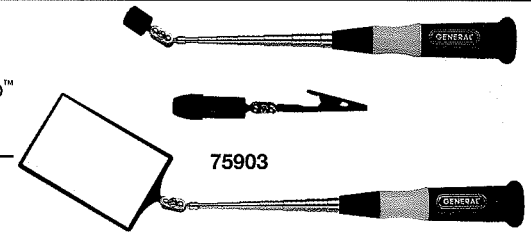

"LITE-IT" CLIP-ON MINI LIGHT

- Clips on to anything, anytime, anywhere for instant, direct light.
- Light is fastened to a rugged high-impact ABS plastic Alligator Clip with a double ball joint that adjusts to any angle.

- 4 Alkaline, LR41, batteries with a battery life of 48 continuous hours.
- ED Bulb has a life of 100,000 hours of continuous use.

UPC	NO.	PKG.
58001 6	580	Carded

#157846 580

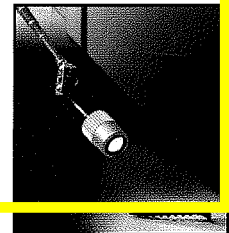

TELESCOPING MINI LIGHT & MINI LIGHT WITH MAGNETIC PICK-UP

- Mini Light and Mini Light with 2 lb. Neodymium Magnetic pick-up are both fastened to a stainless steel telescoping wand molded into a rugged high-impact ABS plastic handle.
- Both telescope from 7-3/4" - 28-3/4" (197mm - 720mm).
- 4 Alkaline, LR41, batteries with a battery life of 48 continuous hours.

- Light Bulb has a life of 100,000 hours of continuous use.
- No. 759582 has a 2 lb. smooth surface pull capacity Neodymium donut magnet.
- Precision engineered 750 Series Versa-Grip™ handle for maximum performance.

UPC	NO.	PKG.
75966 5	759581	Carded
75967 2	759582	Carded

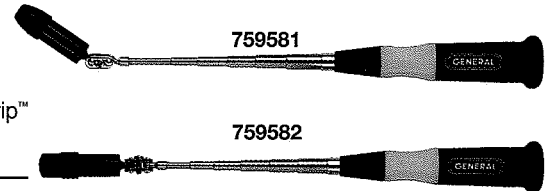

TELESCOPING ALLIGATOR CLIP

- Ideal for lighting Pilot Lights and Barbeques.
- Stainless Steel Alligator Clip has a jaw capacity of 3/16" (5mm).
- High strength corrosion resistant stainless steel wand extends from 7-3/8" (187mm) to 28" (711mm).

- Double ball joint connection permits infinite angle adjustments
- Precision engineered 750 Series Versa-Grip™ handle for maximum performance.

UPC	NO.	PKG.
75965 8	759400	Carded

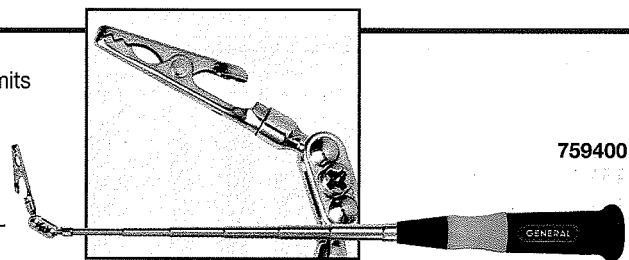

"CUT-IT" NO. 1 & NO. 2 PRECISION HOBBY KNIVES

- No. 1 Knife offers the versatility of fine, intricate cutting. No. 2 Knife offers heavy-duty carving and scraping.
- Heavy-duty locking screw chuck holds knife blade securely in place.
- Both precision knife handles accept industry standard blades and accessories.

- Precision engineered 700 and 750 Series Versa-Grip™ handle for maximum performance.

UPC	NO.	PKG.
70959 2	70601 No. 1	Carded
70960 8	75601 No. 2	Carded

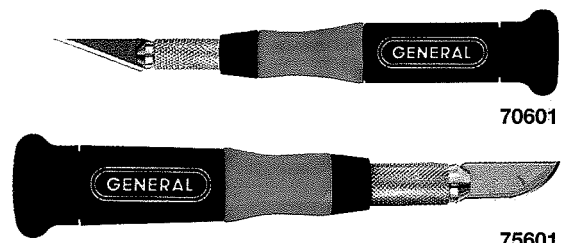

15-PIECE "CUT-IT" NO. 1 PRECISION HOBBY KNIFE SET

- Offers the versatility of fine, intricate cutting.
- Ergonomically designed handle with contoured head allows for greater control and comfort.
- Heavy-duty locking screw chuck holds blades securely in place.
- Set includes:
 - No. 1 Precision knife handle (70601)
 - 5 each of No. 10 short radius
 - No. 11 sharp angle
 - No. 16 short angle surgically sharp blades.
- Precision engineered 700 Series Versa-Grip™ handle for maximum performance.

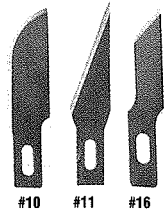
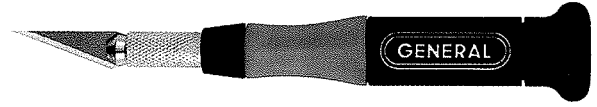
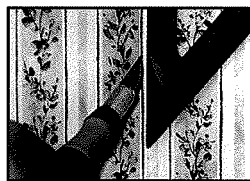
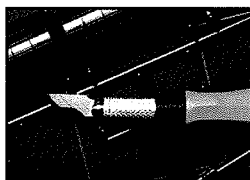

All General Tools UltraTech™ precision knife handles accept industry standard blades and accessories

UPC	NO.	PKG.
70961 5	70615	Carded

